

AC-600F

Features

- ▶ Load Capacity
1,103 lbs/ea | 2,205 lbs w/4
- ▶ Swivel Plate Top
- ▶ Unit Weight **2.78 lbs**



Dimensions

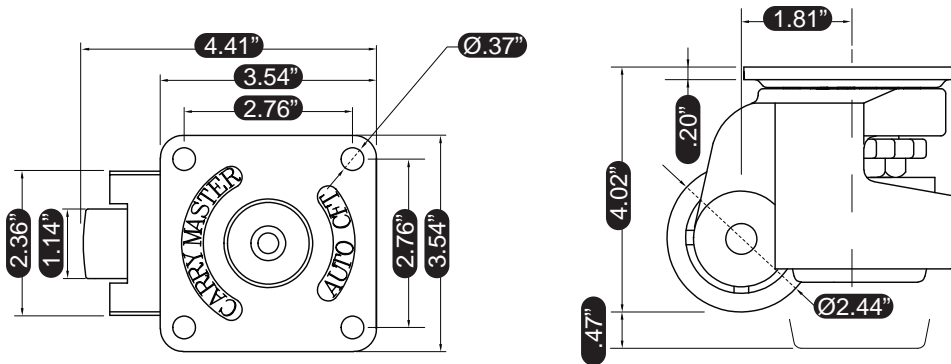

Materials & Treatments

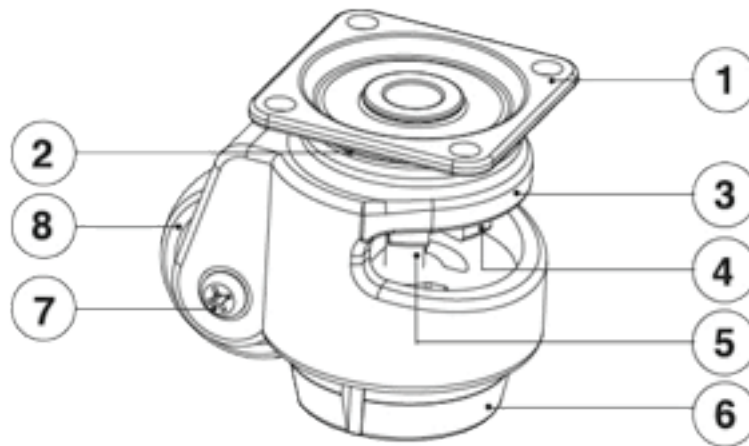

Parts	Materials	Treatments
1	Top Plate	SPC & S45C Zn Galvanized
2	Ball	STB2 Ni-Cr
3	Frame	ALDC12 Powder Coated
4	Handle	ABS Red

Parts	Materials	Treatments
5	Leveler	Swrch 10A Zn Galvanized
6	Foot	NBR Black
7	Pin	Swrch 10A Zn Galvanized
8	Wheel	PA6 Black