

# SINGLE LINE RESISTANCE SYSTEMS

Designing, Specifying, Ordering  
and Installing a Centralized  
Lubrication System

## Contents

Forward .....	2
Using this Brochure .....	3
Glossary .....	3
<b>1) Introduction.....</b>	<b>4</b>
System Description .....	4
Advantages .....	4
System Elements .....	5
<b>2) Selecting Resistance Fittings.....</b>	<b>6</b>
Overview .....	6
Nomenclature .....	6
Selection .....	6
Mounting .....	6
Flow Rate/Flow Value .....	7
System Type .....	7
How to Order .....	7
<b>3) System Design .....</b>	<b>8</b>
Introduction .....	8
Checklist .....	9
Proving the System .....	9
<b>4) Manual Systems .....</b>	<b>10</b>
Principle of Operation .....	10
Select the Right Lubricator .....	10
Lubricators .....	11
Meter Units .....	11

<b>5) Automatic Systems .....</b>	<b>12</b>
Principle of Operation .....	12
Select the Right Lubricator .....	12
Lubricators .....	13
Meter Units .....	13
<b>6) Automatic Continuous Systems.....</b>	<b>14</b>
Principle of Operation .....	14
Setting the System Pressure.....	14
Lubricators .....	15
Control Units.....	15
<b>7) Distribution Network .....</b>	<b>16</b>
Principle of Operation .....	16
System Assembly .....	16
When to Use Compression Bushings .....	17
When to Use Compression Nuts .....	17
Need Help?.....	18
<b>8) Installation &amp; Mounting .....</b>	<b>18</b>
Installation Tips .....	18
Ordering Tips .....	18
<b>Bill of Materials .....</b>	<b>19</b>

## Forward

Bijur Delimon International has divided this brochure into eight major sections to help familiarize you with the process of designing, ordering and installing a Single Line Resistance (SLR) system. Each section is self-contained and the information is presented on a two-page spread with helpful hints and related technical information located in the outside columns.

After you have designed your SLR system, use the Bill of Materials (see page 19) to assist in identifying all the required components.

## Using this Brochure

You will become familiar with the selection, specification and operation of a SLR system after reviewing this brochure. When designing, specifying and ordering a system it will be helpful to become familiar with the various terminology. Knowledge of lubrication terms will ensure accurate communication when discussing your lubrication needs with a Bijur Delimon sales representative.

It is necessary to identify each lubrication point on the machinery by its type, its location and the amount of oil it requires (see Section 3 for step-by-step procedure).

### Important Note

Throughout this brochure, a vertical milling machine is used as an example of a typical application for a SLR system. This installation utilizes a Bijur Delimon manual lubricator to cover nine lubrication points.

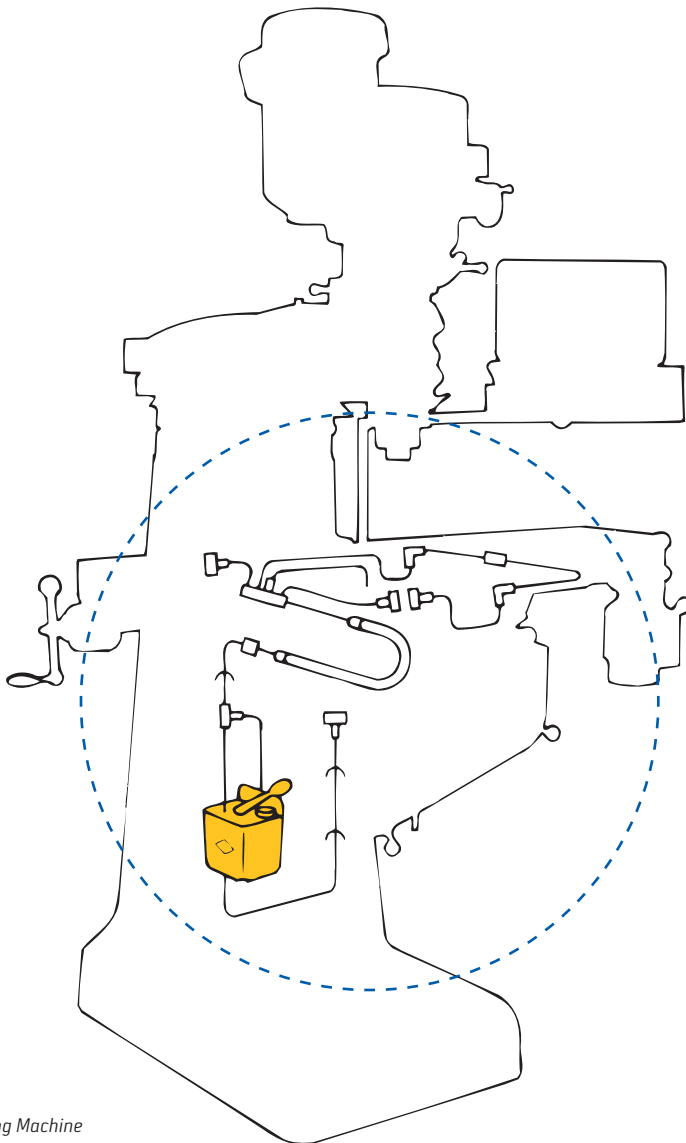

Vertical Milling Machine

## Glossary

- Automatic system** – A system actuated by a timing mechanism; does not require manual operation.
- Centistokes** – A unit of measure when describing viscosity; a property characteristic of oil when a fixed amount flows through a capillary tube under the force of gravity.
- Centralized lubrication system** – A system where all friction points on the equipment are fed by lubricant drawn from a central point or reservoir.
- Compression bushing** – Male distribution tubing connection fitting.
- Compression fitting** – Part of the distribution network used to make an oil-tight tubing connection.
- Compression nut** – Female distribution tubing connection fitting.
- Continuous system** – Supplies small, measured quantities of lubricant to each point in the system without allowing excess oil to collect.
- Control unit (type C)** – The resistance fitting used with continuous-type systems.
- Cyclic system** – Supplies lubricant to points in the system on a predetermined, intermittent basis.
- Distribution network or system** – All tubing and other connecting hardware used to connect the lubricator to various lubrication points on the machinery.
- Resistance fitting** – A general classification of Bijur Delimon proportioning devices installed at each point of lubrication, commonly referred to as meter units or control units.
- Friction** – A force that slows things in motion; lubrication counteracts friction.
- Friction point** – Used to refer to all bearings or sliding surfaces which require regular lubrication. Some commonly used terms include: bearing, lube point, slides and ways, chains, cams, etc.
- Loss system** – Lubrication system in which oil is not recovered after it has been delivered to the friction point.
- Lubricator** – Also referred to as the “pump,” it may be activated either manually, mechanically or by self-contained motor, depending on the system requirements.
- Meter unit (type F)** – The specific type of resistance fitting required when installing a manual or automatic cyclic lubrication system.
- Recirculating system** – Lubrication system in which oil is returned to a sump or reservoir for reuse after passing through points of lubrication.
- SSU** – Referred to as “Saybolt Seconds Universal”; a measurement of time (seconds) required for a fixed amount of oil to flow through a known size orifice at a given temperature; also referred to as “Saybolt Universal Seconds.”
- Sleeve** – A small metal ring that slips over tubing end used to create oil tight connection when compressed by a compression fitting; sometimes referred to as a ferrule.
- Tubing clips** – Small clamps used to fix distribution tubing to the fixed contours of the equipment.
- Viscosity** – A unit of measure used to describe flow characteristics of an oil at a given temperature.

# Introduction

## Before You Begin

Various areas of this brochure reference key tables and figures. For clarity, be sure to read all content and follow any provided instructions.

Remember, help is only a telephone call away. Call for assistance on any system design or operational issue you encounter.

## Oil Selection

A clean mineral oil that meets the original equipment manufacturer's (OEM) specifications for type and viscosity (20-2000 centistokes or 100-8000 SSU) is recommended. The oil must be able to pass through a 25-40 micron filter while at operating temperature.

**Note:** 1 cubic centimeter of oil is equal to approximately 30 drops.

### Additional Help:

Bijur Delimon's engineering laboratory has evaluated most popular industrial oils in use today. Our engineers will be happy to specify a particular viscosity range for your application. Contact your nearest Bijur Delimon representative if you are in doubt when selecting an oil for your SLR system.

## System Description

Bijur Delimon's low pressure oil lubrication systems are designed for light, medium and heavy machinery requiring up to 100 points of lubrication. Two types of systems (manual and automatic) are available to meet virtually any industrial application:

1. **Manual systems** are ideally suited for machinery which can be lubricated by a hand actuated, intermittently fed oil discharge system on an occasional basis.
2. **Automatic systems** are ideally suited for machinery requiring an uninterrupted discharge of oil either regularly timed or continuous. Automatic systems are actuated by a self-contained timing mechanism or by a mechanical drive mechanism connected to the equipment being lubricated.

## Advantages

Bijur Delimon SLR systems are compact, economical and relatively simple to operate and maintain. The system is ideally suited for machinery or equipment which displays closely configured bearing clusters or groups (see Figure 1.1).

A precisely controlled discharge of oil is delivered to each point while the machine is in operation. The system provides a clean film of oil between critical bearing surfaces to keep friction and wear to a minimum. Machinery life is extended and production efficiency is maintained (see Figure 1.2).

### WARNING!

A single resistance fitting can supply one point in the system.

FIGURE 1.1

### Installation of Manual Lubricator

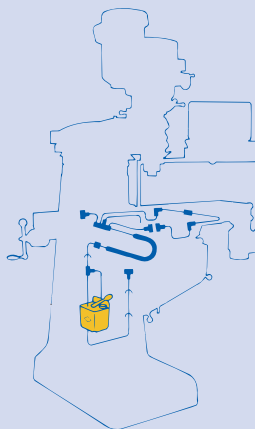
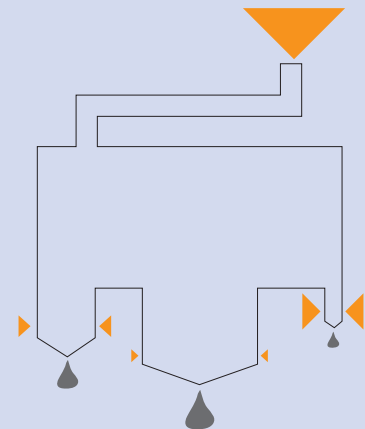

FIGURE 1.2

### Principle of Metered Lubrication by Resistance Fittings



## System Elements

A Bijur Delimon SLR system is a highly reliable, low pressure oil lubrication system which consists of three basic elements:

### 1) Lubricator (Pump) and Reservoir

Bijur Delimon lubricators are either actuated manually or automatically.

- + **Manual lubricators** are operated on demand by the machine operator.
- + **Automatic lubricators** are designed to operate at predetermined, regular intervals. Typically, they're controlled by a timing mechanism or direct drive with the equipment.

### 2) Resistance Fittings

A resistance fitting is the part of the system that proportions and dispenses oil to a friction point. It must be remembered that the amount of oil delivered to each point in the system is apportioned by a resistance fitting, not the lubricator. The lubricator controls the volume of oil available for overall system consumption.

Bijur Delimon offers ten different sized flow devices. Each one is designed for one-way delivery of a proportioned quantity of oil to a bearing or surface.

### 3) Distribution Network

Tubing plus various junctions, adapters, clips and connection hardware make up the distribution network. The network connects the lubricator and individual resistance fittings located at or near the friction points. Typically, a single line (5/32" O.D.) tube is branched at convenient locations to meet the requirements of the machine's bearing arrangement.

## Factors Affecting the Lubrication Process

All Bijur Delimon SLR systems are designed to adequately protect machinery under a wide range of operating and environmental conditions. Properly lubricated surfaces are a critical component of machinery operation. Factors which affect oil flow to points in the system include:

- + Lubricant viscosity
- + Machine speed (for mechanical drives)
- + Operating temperature
- + Ambient temperature
- + System (lubrication) pressure
- + Resistance fittings

LUBRICATORS

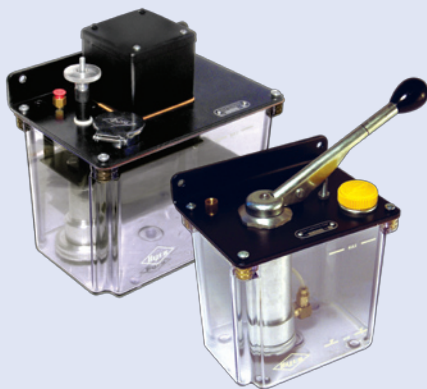

RESISTANCE FITTINGS

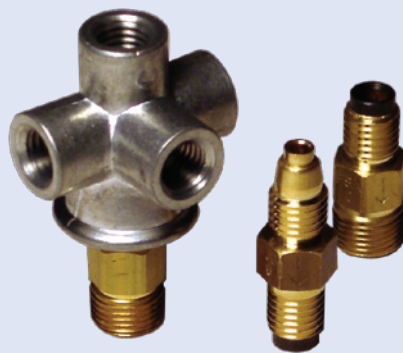

DISTRIBUTION NETWORK





# Selecting Resistance Fittings

## Overview

Before designing your Bijur Delimon SLR system, it is critical to understand the function of resistance fittings and why they are important to your machinery.

Each resistance fitting is a fixed component designed for one-way delivery of a precise quantity of oil to a bearing or surface.

Also, the amount of oil delivered to each bearing point is apportioned by the resistance fitting, not the lubricator. The lubricator controls the volume of oil available for overall system consumption (see Figure 1.2).

Each lubrication point on the machine must have an assigned resistance fitting. The size of the resistance fitting depends upon the calculated oil requirement for that bearing and relative proportioning ratios of the rest of the system (see Table 2.1).

*Caution: A single resistance fitting can supply oil to only one point.*

## Nomenclature

Bijur Delimon refers to the resistance fittings used with automatic cyclic systems as meter units. Each meter unit is shipped with a fixed orifice, a moving pin and an internal check valve. The valve ensures precise discharge without loss of system priming between operating cycles (see Figure 2.1). The orifice and pin size create the metering rate.

The resistance fittings used with continuous systems are called control units. Each control unit proportions a continuous rate of flow and does not contain a check valve (see Figure 2.2). The rate of flow at each point is controlled by the size of the spiral opening in the control unit.

Both types of Bijur Delimon resistance fittings (meter and control units), may be mounted in any position without affecting operation.

## Selection

All resistance fittings have been designed to provide the proper amount of resistance to the flow of oil as it passes through it. The amount of resistance determines the amount of lubricant that each point receives. If the proper size resistance fittings are selected, measured amounts of lubricant will provide adequate protection for your machinery.

It is important to specify the proper size resistance fitting for each point in the system since both “over” and “under” lubrication can seriously affect machine operation and life. All Bijur Delimon resistance fittings are clearly marked for type of mounting and rate of flow.

## Mounting

Both meter units and control units may be installed in any of three basic configurations:

1. **Straight** - mounted at the bearing
2. **Tee Junction** - mounted at the bearing
3. **Junction** - removed from the bearing friction point

Each type resistance fitting is engineered to deliver a predictable and repeatable flow

of oil to a bearing point regardless of its distance from the lubricator or pump.

Resistance fittings may either be direct mounted at the bearing or off-set from the point of lubrication. When direct mounting a resistance fitting into a bearing, either

TABLE 2.1

## Calculating Oil Requirement

Bearing Type	Calculate Oil Requirement (cc/hour) by Multiplying
Anti-friction bearing	0.10 x bearing shaft diameter (") x number of rows (balls, rollers, etc.)
Plain bearings and drive screws	0.15 x bearing shaft diameter (") x bearing length (")
Gears	0.30 x gear pitch diameter (") x face width (")
Cams	0.08 x surface area (sq. in.)
Chains	0.05 x length (") x width (")
Slides and way flat	0.04 x [(length of moving member (") + travel (")) x width (")]
Cylindrical	0.15 x diameter (") x [(length of moving member (") + travel ("))]
Ball bearing	0.03 X travel of moving member (") x number of rows

Figure 2.1: Meter Unit (Type F)

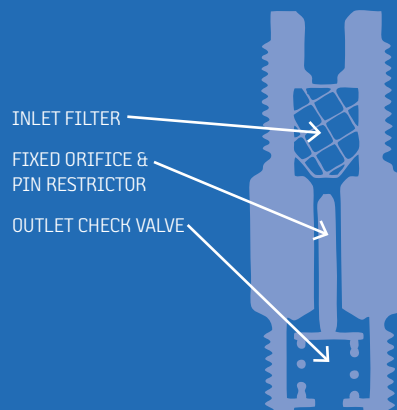
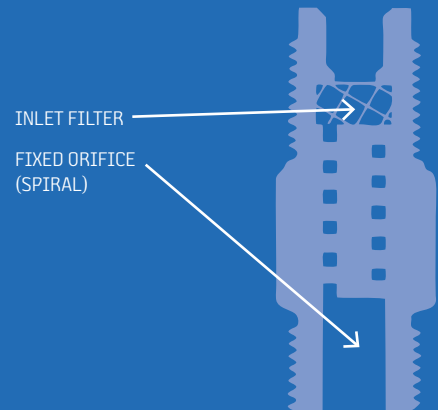
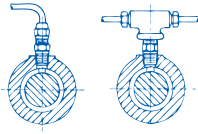

Figure 2.2: Control Unit (Type C)



straight units or tee units are used. They assure the most rapid transfer of oil.



For drip-feed lubrication – cams, gears, chains, etc. – a junction unit is screwed into a standard junction block in the distribution line.

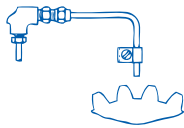

## Flow Rate/Flow Value

**Flow rate** is a designation assigned to a resistance fitting and is identified by a stamped arrow on the body of the unit. Flow rate describes the relative oil flow from the unit. Each numeric increase doubles flow delivery from the unit.

**Flow value** is simply a numeric designation used to refer to the oil permitted to flow through the resistance fitting. The value is relative and does not correlate to either volumetric discharge or amount of

discharge on a unit/time basis. Flow value is designated by the Greek letter  $\Phi$  (phi).

This provides a convenient method of sizing pumps and resistance fittings in the system.

## System Type

Resistance fittings should match the type of system you are designing. For example, a continuous loss system would typically require proportioning devices with ratings from 5/0 to 0; a cyclic system from 3/0 to 3; and a continuous re-circulating system from 1 to 5 (see Table 2.2).

Bijur Delimon offers a total of ten different sizes of resistance fittings ranging from very slow discharge (size 5/0) to very fast discharge (size 5) (see Table 2.3).

When designing your system, it is important to understand that each increase in flow rate doubles the relative flow value and thus, doubles the amount of oil delivered. For example, a 3/0 unit delivers twice as much oil as a 4/0 unit.

TABLE 2.2

## Recommended Flow Rates

Flow Rate	Relative Proportional Delivery Rate	
5/0	1	CONTINUOUS "LOSS"
4/0	2	
3/0	4	CYCLIC "LOSS"
00	8	
0	16	CONTINUOUS "RE-CIRCULATING"
1	32	
2	64	
3	128	
4	256	
5	512	

TABLE 2.3

## Flow Delivery & Value

Flow Rate	Flow Value ( $\Phi$ )	Relative Discharge Rate
5/0	0.3	extra, extra slow
4/0	0.6	
3/0	1.2	slow
00	2.5	medium slow
0	5	
1	10	
2	20	medium fast
3	40	fast
4	80	
5	160	extra, extra fast

## How to Order

Meter and control units have a letter and number designation stamped on the flat surface of the hexagonal body. Part numbers are listed in the tables on pages 11, 13 and 15.

When ordering, specify the complete name and part number, e.g. Meter Unit, Type FSA-0, Part #B1083. (Use the chart to the right as reference only for letter and number designation definitions.)

### Unit & Thread Type

- C- Control Unit
- F- Imperial thread\*
- A- Metric thread\*

### Type, Location & Mating Parts

- B- British Thread Tee-Type
- F- High Flow Type\*\*
- J- Junction Type
- K- Insert Type
- R- Reverse Flow Type
- S- Straight Type
- T- Tee Type

### Flow Rate

- 5/0- Extra, extra slow\*\*
- 4/0- \*\*
- 3/0- Slow
- 00- Medium slow
- 0-
- 1-
- 2- Medium fast
- 3- Fast
- 4-
- 5- Extra, extra fast

\* Meter Unit only  
\*\* Control Unit only

See **Datasheet #35470: Meter Units** and **Datasheet #35478: Control Units** for more information regarding type, location and mating parts.

# System Design

## Lubricator Selection Tips

- + The rated output (cc/discharge) should be adequate to supply total oil required by each bearing in the system, regardless of lubricator type specified for your system.
- + For automatic systems, the input speed should be within limits of the lubricator selected.
- + For continuous systems, the motor voltage and cycle data should be compatible and wiring should be sufficient for motor phase.
- + Total flow value ( $\Phi T$ ) of system should not exceed ( $\Phi$ ) rating of pump selected.
- + Verify pressure range of shop air when specifying a pneumatic lubricator.
- + If in doubt, check with individual *Bijur Delimon Datasheets* that describe the specified lubricator or contact your Bijur Delimon sales representative.

## Introduction

Before starting to design your Bijur Delimon SLR system, you should use the following checklist. Periodically, you may need to reference the glossary (see page 3) and information about the different systems, which include:

- + Manual systems (see Section 4)
- + Automatic systems (see Section 5)
- + Automatic continuous systems (see Section 6)

To ensure a proper system is designed, you should understand the importance of selecting the proper size resistance fittings for each point (see Section 2).

Creating a schematic diagram of the equipment will help locate and specify each point requiring lubrication (see Figure 3.1). The schematic will also ensure that no points are overlooked. Installation of your system will be simplified if you reference your schematic once you receive your system components.

FIGURE 3.1  
System Schematic

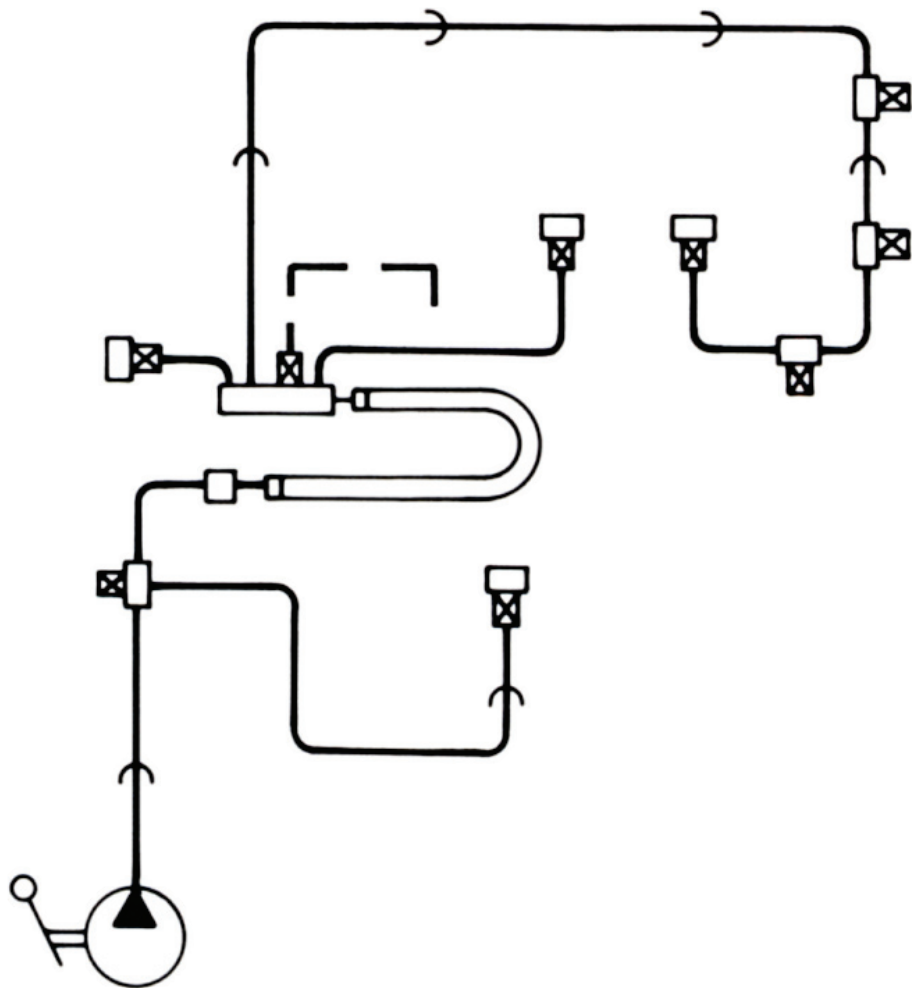



## Checklist

- 1. Locate and identify friction points** or types of bearings on the equipment to be lubricated. Determine accurate size and configuration of each bearing point by referring to the machine manual. (Estimate bearing size by visual inspection if manual is unavailable.) At this point, complete your system schematic.
- 2. Calculate oil requirement (cc/hr)** for individual bearing points and record amount next to each point on the schematic. Good lubrication practices demand the oil requirement of each point be calculated separately (see Table 2.1).
- 3. Calculate total system oil requirement** by finding the sum of individual oil requirements (per point). Record the total system oil requirement on your schematic.
- 4. Select a lubricator** that will deliver sufficient quantities of oil to the entire system. For this example, a lubricator with a maximum discharge capacity of at least 16 cc/hour is desirable. (See Lubricator Specification tables in Sections 4-6.)
- 5. Specify resistance fittings** for each point in the system. First, select the proper flow rate for the system type you are designing – continuous loss, cyclic or continuous recirculating (see Table 3.1).

Next, assign the sizes of the resistance fittings. Start with the resistance fitting near mid-range in the point that requires the least amount of oil. Continue assigning sizes of all other resistance fittings in the system based on their relative size (discharge volume) to other points. Points that require similar amounts of oil will be supplied from similar sized resistance fittings.

- 6. Determine total system flow value (ΦT)** by adding the flow value (Φ) of each resistance fitting. Next, multiply the flow value of each resistance fitting to the number of points in that group (see Figure 3.1).

**For cyclic systems:** Verify selection of resistance fittings with total system requirement. If total (Φ) exceeds pump rating, select a larger pump or smaller resistance fittings.

**For continuous systems:** Determine and specify distribution tubing, fittings, junctions and connectors. (See Section 6 to calculate system operating pressure.)

## Proving the System

To prove that the system you designed is adequate, compare the calculated oil discharge with the actual discharge from the lubricator you selected. To do this, divide device flow value by total system flow value, then multiply by pump discharge volume. The result is the actual metered discharge for that point (see Figure 3.2).

FIGURE 3.2

## Verifying System Capability

To prove that the cyclic system that was just designed is adequate, compare the **flow characteristic** of each meter unit to the **flow value** of the overall system. Multiply this ratio to the total pump shot size and you will calculate metered discharge amount per point.

### Example: Proposed System

Pump Discharge (Type L5P-R) 5.00 cc/cycle

Qty	Resistance Fitting	Flow Value
8	#1 Meter Unit Flow Value (Φ) 10 each	80
1	#0 Meter Unit Flow Value (Φ) 5 each	5
Total System Flow Value (ΦT)		85

### Calculations

Delivery from each #1 meter unit:

$$10 \div 85 \times 5 \text{ cc discharge} = 0.59 \text{ cc/shot}$$

Delivery from each #0 meter unit:

$$5 \div 85 \times 5 \text{ cc discharge} = 0.3 \text{ cc/shot}$$

Summary of total output is:

$$8 \text{ meter units} \times 0.59 \text{ cc discharge} = 4.7 \text{ cc/shot}$$

$$1 \text{ meter units} \times 0.3 \text{ cc discharge} = 0.3 \text{ cc/shot}$$

**Total = 5.0 CC discharge**

TABLE 3.1

## Recommended Flow Rates

Flow Rate	Flow Value	
5/0	0.3	CONTINUOUS "LOSS"
4/0	0.6	
3/0	1.2	
00	2.5	CYCLIC "LOSS"
0	5.0	
1	10.0	CONTINUOUS "RE-CIRCULATING"
2	20.0	
3	40.0	
4	80.0	
5	160.0	

# Manual Systems

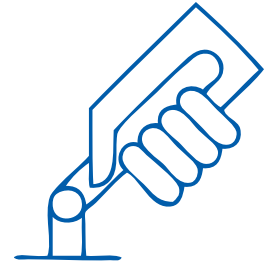

## Important

- + Always use meter units (Type F) in cyclic systems (see Section 2). (Never use continuous operation control units (Type C) in cyclic systems.)
- + A single meter unit can supply oil to only one point in the system.
- + Always use pressure gauges with finger indicator follower in cyclic systems to observe normal system operating pressure.

## Troubleshooting

System condition can be diagnosed by observing the rate of return of the handle or lever on a manual lubricator as follows:

Return	Condition
slow, steady	normal operation
snaps back or does not return to rest position	clogged filter or broken line
none	crushed line

During the discharge cycle of the systems, there should be a maximum peak pressure of 25 psi. (If you experience otherwise, see Section 3: System Design.)

## Principle of Operation

Bijur Delimon's manual lubricators are operated by activating a piston which is connected to either a push lever or a pull handle.

Manual lubricators contain spring-actuated piston pumps.

As the lubricator spring is compressed by actuating the handle, a measured quantity of oil is drawn into the piston chamber. Release of the handle forces the inlet check valve to close and the oil "shot" is forced into the distribution system under pressure of the compressed spring.

When oil is required at lubrication points, raising of lubricator handle or lowering of push lever will activate the pump, then oil delivery becomes automatic to each point in the system network.

Every Bijur Delimon manual lubricator comes with a filter to prevent contaminants from entering the distribution lines and reaching points of lubrication.

## Select the Right Lubricator

Bijur Delimon offers manual lubricators to meet virtually any industrial lubrication need. Lubricators are available in different combinations that include:

- + pump discharge volume
- + operating handle configuration
- + reservoir capacity
- + mounting position

Proper selection of a manual lubricator is largely determined by a careful analysis of total system requirements (see Section 3).

*Caution: Total sum value of all meter units in a system should not exceed maximum ( $\Phi T$ ) total for individual pumps. (Find datasheets at [www.bijurdelimon.com](http://www.bijurdelimon.com) for more information.)*

TABLE 4.1  
Lubricator Specifications for Manual Systems

*Note: Basic lubricators are listed. Other configurations are available on some models - check datasheets. Use Type F meter units with listed lubricators.*

Type	Maximum Flow Value ( $\Phi T$ )	Method of Operation	Delivery	Maximum Discharge (cc/shot)	Pressure (psi)	Approximate # Points Served	Reservoir Capacity	Part #	Datasheet	Mounting
L2P	150	pull knob	adjustable	2.0	30	1-30	200cc	C2988C	24797	bracket
L5P	220	push lever	adjustable	5.0	75	1-50	1 pint	D3174C	21967	bracket
L18P	850	push lever	adjustable	18.0	65	10-100	1 liter	D3033C	21968	bracket
HAP-P	800	push lever	adjustable	15.0	60	5-75	1 pint	D3221C	24375	bracket
HIP-P	800	pull handle	adjustable	15.0	30	5-75	1 pint	D3204C	24374	bracket
KIB	650	pull handle	adjustable	7.5	70	1-50	sump mounted	C1957-2 C1957-3	35530	bracket
KIC	220	pull handle	adjustable	5.0	50	1-40	sump mounted	C2367-1 C2367-2	35530	bracket

## Lubricators

### L2P



### L5P



### HIP-P



### HAP-P



FIGURE 4.1

## Suitability of Cyclic Pump for Distribution System Meter Units

Complete the following to check that a manual or automatic cyclic pump is not over-extended (too many points) and cannot distribute the required discharge to each point properly.

1. Find various pump discharges based on total number of points (meter units) in the system.
2. Check that total flow value ( $\Phi T$ ) of all meter units in the system never exceeds the maximum permissible value listed (see Table 3.3).
3. Using the scenario from Figure 3.2, refer to Table 7.1 to determine:
 

*Total System Flow Value ( $\Phi T$ ) = 85*  
*Maximum permissible value = 750*  
*(based on 10 points at 5cc discharge)*
4. This system is within acceptable design specifications.

## Meter Units

	Straight Mounting		Junction Mounting		Tee Mounting			
FLOW	FSA	FT	FJD	FJB	FTA	FTC	FTG	FTD
3/0	B6526	B6529	B6085	B6548	B6549	B6551	B6553	B6552
00	B1620	B1398	B3773	B2494	B1524	B1530	B2759	B1532
0	B1083	B1112	B3774	B2495	B1071	B1098	B2760	B1106
1	B1084	B1113	B3775	B2496	B1072	B1099	B2761	B1107
2	B1085	B1114	B3776	B2497	B1073	B1100	B2762	B1108
3	B1086	B1115	B3777	B2498	B1074	B1101	B2763	B1109
4	B1087	B1116	B3778	B2499	B1075	B1102	B2764	B1110
5	B1088	B1117	B3789	B2500	B1076	B1103	B2765	B1111

Meter Units for Cyclic Systems

Flow Rate	Flow Value	Oil Discharge Rate
3/0	1.2	slow
00	2.5	medium slow
0	5.0	
1	10	
2	20	medium fast
3	40	fast
4	80	
5	160	extra, extra fast

Note: See Brochure #151: Specialty Fluid Fittings for complete listing of Bijur Delimon specialty fittings.

# Automatic Systems

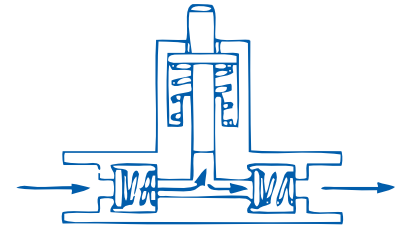

## Important

- + Always use meter units (Type F) in cyclic systems (see Section 2). (Never use continuous operation control units [Type C] in cyclic systems.)
- + A single meter unit can supply oil to only one point in the system.
- + Always use pressure gauges with finger indicator follower in cyclic systems to observe normal system operating pressure.

## Helpful Hint

During the discharge cycle of the systems, there should be a maximum peak pressure of 25 psi. (If you experience otherwise, see Section 3: System Design.)

## Principle of Operation

Bijur Delimon automatic lubrication systems can be actuated by machine operation or as complete self-contained motorized units. Cyclic systems utilize meter units to proportion oil to lubrication points throughout the system.

Various system actuation methods are available in automatic systems:

- + rotary-driven from machinery or equipment (cyclic)
- + self-contained motor-driven with built-in gear reduction (cyclic)
- + timer actuated pneumatic pumps (cyclic)
- + timer, controller or PLS actuated gear pumps

Discharge volume of a “cyclic” lubricator is normally 1.0 or 5.0 cubic centimeters. A gear pump can range from 167cc/min - 500cc/min. Typically, oil volume may be reduced by 50% depending on the application. Larger discharge amounts are also available if required. Contact your Bijur Delimon sales engineer for recommendations and procedures.

The lubrication operational cycle is normally a function of machinery size and number of points. A quick-feed activator is normally supplied on the lubricator to rapidly fill distribution tubing after installation and to verify operation at any time.

## Select the Right Lubricator

Various discharge cycles are available to meet most industrial lubrication needs. Steps should be taken to ensure that the lubrication system does not become overextended. Proper selection of an automatic cyclic lubricator is largely determined by a careful analysis of total system requirements (see Section 3).

In special situations in which larger output cyclic discharge systems are required, please contact your Bijur Delimon sales representative.

*Note: Electronic cycle pressure monitors are available to safeguard the system (see Datasheet #21956: Electronic Pressure Monitor for more information).*

TABLE 5.1  
Lubricator Specifications for Automatic Systems

*Note: Basic lubricators are listed. Other configurations are available on some models - check datasheets. Use Type F meter units with listed lubricators.*

Type	Maximum Flow Value ( $\phi$ T)	Method of Operation	Delivery	Maximum Discharge	Pressure (psi)	Approximate # Points Served	Reservoir Capacity	Part #	Datasheet	Pump Type
AA	900	rotary/motor	adjustable	32.0cc/shot	> 200	10-200	optional	various	A-4	gear
AB	900	rotary/motor	adjustable	32.0cc/shot	> 200	10-200	optional	various	A-4	gear
TM-1	100	motor	adjustable	1.0cc/shot	25-50	1-20	1 pint, 1 liter	various	35477	piston
TM-5	220	motor	adjustable	5.0cc/shot	25-60	50	1 liter, 1 gallon	various	21836	piston
TMD-5	220	motor	adjustable	5.0cc/shot	25-60	55	1.8 liter	various	24117	piston
YP-8	700	pneumatic	adjustable	8.0cc/shot	25-75	70	1 liter	various	24794	piston
SureFire	*	motor	adjustable	167-500 cc/min	75	100	1.8, 2.7, 6, 12 liter	various	35466	gear

\* Max flow value varies by application. Contact Bijur Delimon for assistance in system setup.

## Lubricators

### TM-1

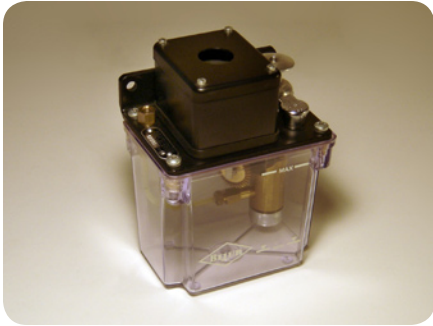

### TM-5

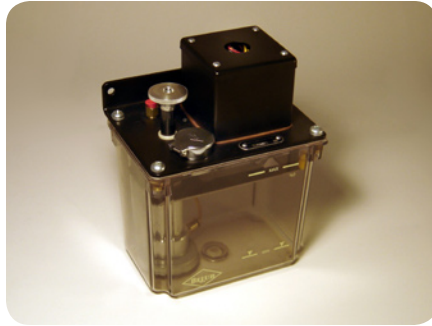

### SureFire SLR

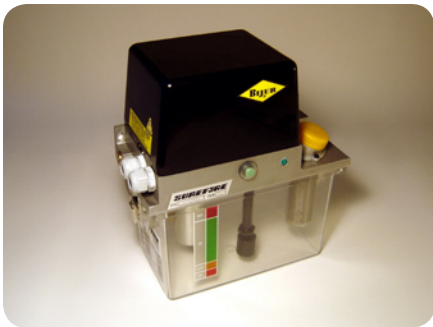

## Meter Units

	Straight Mounting		Junction Mounting		Tee Mounting			
FLOW	FSA	FT	FJD	FJB	FTA	FTC	FTG	FTD
3/0	B6526	B6529	B6085	B6548	B6549	B6551	B6553	B6552
00	B1620	B1398	B3773	B2494	B1524	B1530	B2759	B1532
0	B1083	B1112	B3774	B2495	B1071	B1098	B2760	B1106
1	B1084	B1113	B3775	B2496	B1072	B1099	B2761	B1107
2	B1085	B1114	B3776	B2497	B1073	B1100	B2762	B1108
3	B1086	B1115	B3777	B2498	B1074	B1101	B2763	B1109
4	B1087	B1116	B3778	B2499	B1075	B1102	B2764	B1110
5	B1088	B1117	B3789	B2500	B1076	B1103	B2765	B1111

Note: See Brochure #151: Specialty Fluid Fittings for complete listing of Bijur Delimon specialty fittings.

FIGURE 4.1

## Suitability of Cyclic Pump for Distribution System Meter Units

Complete the following to check that a manual or automatic cyclic pump is not over-extended (too many points) and cannot distribute the required discharge to each point properly.

1. Find various pump discharges based on total number of points (meter units) in the system.
2. Check that total flow value ( $\Phi T$ ) of all meter units in the system never exceeds the maximum permissible value listed (see Table 3.3).
3. Using the scenario from Figure 3.2, refer to Table 7.1 to determine:
 

*Total System Flow Value ( $\Phi T$ ) = 85*  
*Maximum permissible value = 750*  
*(based on 10 points at 5cc discharge)*
4. This system is within acceptable design specifications.

Meter Units for Cyclic Systems

Flow Rate	Flow Value	Oil Discharge Rate
3/0	1.2	slow
00	2.5	medium slow
0	5.0	
1	10	
2	20	medium fast
3	40	fast
4	80	
5	160	extra, extra fast

# Automatic Continuous Systems

## Important

Always use control units (Type C) in continuous systems (see Section 2). (Never use cyclic operation meter units [Type F] in continuous systems.)

## Helpful Hint

In the main feed line between the pump outlet and the first control unit, a pressure filter (such as Part #19848) must be incorporated to prevent clogged control units.

Always use pressure gauges to observe system operating pressure.

## Loss vs Recirculating

A continuous loss system delivers a constant, relatively small amount of oil to the bearings. The oil is not recovered after delivery and is lost for further use.

On the other hand, a continuous recirculating system delivers a steady, controlled flow of oil to bearings. After leaving the bearing, the oil is collected and re-directed back to the pump for reuse.

## Principle of Operation

Bijur Delimon's continuous lubricators deliver a constant feed of oil to lube points, permitting a uniform coating of oil to protect the friction point. The lubricators may be driven by machine shaft or powered by self-contained electric motor units. Lubricators are available to deliver either constant (nominal) volume output or constant pressure output.

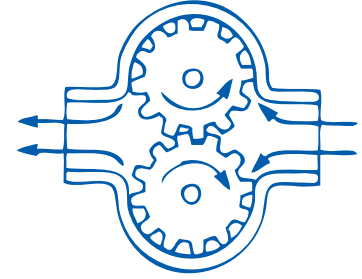

Normally, continuous lubricators are rotary-driven gear pumps which are fully submerged in oil at the bottom of a reservoir and protected by a coarse metal suction screen. Operating pressure is limited to 100 or 200 psi by a built-in relief valve. Discharge from the pump is controlled by a bypass valve. Several size reservoirs (plastic or metal) are available. Also available are pressure monitors and low level oil switches.

## Setting the System Pressure

After the system is fully primed and warmed up, adjust the bypass valve setting at the lubricator to the system operating pressure (see Figure 6.1).

After a prolonged shutdown, the initial operating pressure may register higher than previously set. **Do not re-adjust.** The pressure will revert back to its original setting after it warms up.

TABLE 6.1

## Lubricator Specifications for Auto Continuous Systems

*Note: Basic lubricators are listed. Other configurations are available on some models - check datasheets. Use control units with listed lubricators.*

Type	Maximum Flow Value ( $\phi$ T)	Method of Operation	Delivery	Maximum Discharge (cc/min)	Pressure (psi)	Approximate # Points Served	Reservoir Capacity	Part #	Datasheet	Pump Type
A0	see note	rotary/motor	adjustable	50.0	> 200	100	optional	various	2075	gear
V5B	see note	motor	adjustable	125.0	100 or 200	200	0.5 gallon	various	2163	gear
V5C	see note	motor	adjustable	125.0	100 or 200	200	sump mounted	various	2164	gear
V5W	see note	motor	adjustable	125.0	100 or 200	200	1 gallon	various	24064	gear
V3	see note	motor	adjustable	3.0	100 or 200	20	1 liter		35468	gear
Gear Pump	see note	motor	non-adjustable	50.0	> 100	200	sump mounted		24795, 24796	gear



## Lubricators

### Type V5W



### Type V5B

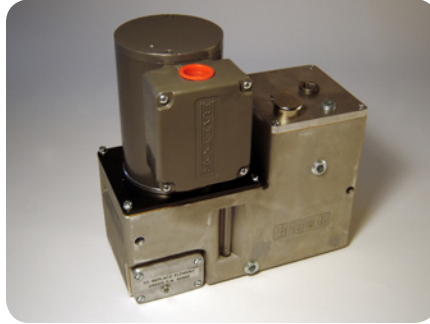

## Control Units

	Straight Mounting		Junction Mounting		Tee Mounting			
↓	CSA	CT	CJD	CJB	CTA	CTC	CTD	CTG
FLOW	B7022	B7028	B7164	B7034	B7174	B7186	B7180	B7212
	B7023	B7029	B7165	B7035	B7175	B7187	B7181	B7213
3/0	B7024	B7030	B7166	B7036	B7176	B7188	B7182	B7214
00	B7025	B7031	B7167	B7037	B7177	B7189	B7183	B7215
0	B7026	B7032	B7168	B7038	B7178	B7190	B7184	B7216
1	B7027	B7033	B7169	B7039	B7179	B7191	B7185	B7217
2	B6757	B6764	B7170	B6817	B6775	B6779	B6783	B6787
3	B6758	B6765	B7171	B6818	B6776	B6780	B6784	B6788
4	B6759	B6766	B7172	B6819	B6777	B6781	B6785	B6789
5	B6760	B6767	B7173	B6820	B6778	B6782	B6786	B6790

Note: See Specialty Fittings Catalog (151) for complete listing of Bijur Delimon specialty fittings.

FIGURE 6.1

## Determine System Pressure

List and calculate the individual oil requirements as described in Section 3. The system pressure setting required to obtain the required discharge or flow can be calculated from the following formula:

$P = FV/\Phi$ , where:

$P$  = pressure at operating temperature

$F$  = Total required (or calculated) flow in cubic centimeters per minute (cc/min)

$V$  = Viscosity of oil in system at operating temperature measured in Saybold Seconds Universal (SSU)

$\Phi$  = Total flow ( $\Phi T$ ) of system

### For example:

A system has 20 points, all No. 0 rate control units and a total discharge of 5 cc/min. A 1000 SSU oil @ 100°F is used in the system.

$$P = 5 \times 1000 \div 100;$$

$$P = 50 \text{ psi}$$

Put another way, each point in this system will be receiving 0.25 cc/min at a continuous working pressure of 50 psi.

Control Units for Continuous Systems		
Flow Rate	Flow Value	Oil Discharge Rate
5/0	0.3	extra, extra slow
4/0	0.6	
3/0	1.2	slow
00	2.5	medium slow
0	5.0	
1	10	
2	20	medium fast
3	40	fast
4	80	
5	160	extra, extra fast

# Distribution Network

## Priming the System

After installation, fill the pump reservoir with recommended oil and then prime the system as follows:

1. Disconnect main line connection at a resistance fitting located mid-way in the distribution system.
2. Actuate the pump manually or automatically to expel air from the system to that point.
3. Reconnect the fitting.
4. Select a tube fitting connection at the farthest point in the distribution system from the pump and actuate the lubricator as above to prime the system and expel air.
5. Reconnect the fitting.
6. Repeat as necessary at other points.

Good preventative maintenance procedures for cyclic and continuous pumps include annually inspecting and changing suction filters and screens.

## System Operation

Bijur Delimon SLR systems are designed to operate at relatively low pressures. Recommended pressure for resistance systems is indicated at right.

A pressure gauge should be installed in the main line as far from the lubricator as practical. To help ensure trouble-free performance, consult Bijur Delimon datasheets for proper operating pressure ranges for the installed system.

System Type	Recommended System Pressure
Manual or Cyclic	20-25 psi (min. peak)
Continuous*	25-180 psi

\* Pressure drop between lubricator and end of main line must not exceed 20% of output pressure at the pump.

## Principle of Operation

All SLR systems – manual, cyclic and continuous – operate at pressures ranging from 25-200 psi. The distribution network connects the lubricator to each application point. Typically, 5/32" diameter tubing is adequate to deliver oil to all connected points. (Small and large diameter tubing is available for systems in different sized areas.) Monitor system operation with optional pressure gauges and automatic pressure switches.

## System Assembly

Compression bushing or nut connections are necessary to connect tubing to the various parts of the lubrication system (see Figure 7.1 and Figure 7.2).

To obtain oil tight connections, cut tubing end squarely and assemble. The end of tubing must be firmly seated in the mounting shoulder, then complete the assembly by turning bushing or nut 2-3 full turns after finger tight.

FIGURE 7.1  
Compression Bushing

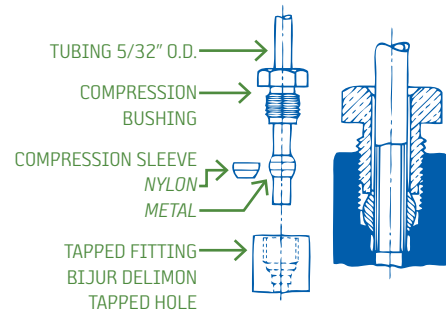

FIGURE 7.2  
Compression Nut

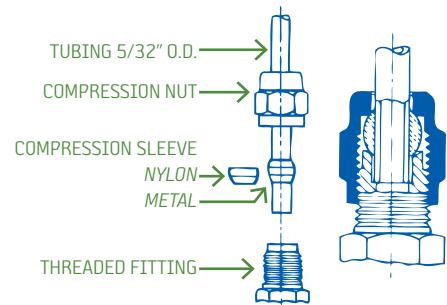

TABLE 7.1

## Cyclic System Discharge

Note: For meter units Type F with minimum viscosity 100 SSU.

Meter Units (#)	Total Oil Discharge (cc/shot or cycle)											
	.25	0.5	1	2	3	4	5	10	15	20	25	30
5	95	145	240	450	700	800						
10	65	100	170	320	550	680	750					
15	55	85	140	250	440	520	350	2900	3500			
20	45	75	115	210	360	460	520	2200	2600	3400	3800	4600
25	39	60	100	180	320	400	450	1700	2000	2500	3000	3600
30	33	50	85	150	275	325	390	1400	1700	2100	2500	3000
40		40	60	120	210	245	290	1100	1300	1600	1900	2200
50			57	90	155	185	220	920	1100	1400	1600	1800
60				60	110	135	160	810	960	1200	1350	1600
70					70	85	96	720	860	1080	1200	1400
80								670	800	1000	1100	1300
90								620	750	920	1020	1200
100								600	700	860	980	1150

FIGURE 7.3

### Straight Mounting

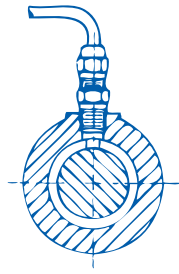

FIGURE 7.4

### Tee Mounting

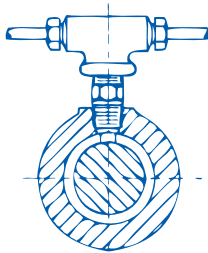
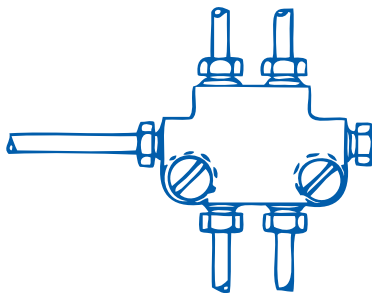

FIGURE 7.5

### Junction Mounting



### When to Use Compression Bushings

Compression Bushings (part #B1371) are used to make oil tight connections at the following:

- + Junctions and junction bars
- + Tee headers (meter and control units)
- + Adapters

A compression sleeve (part #B1061 for metal tubing or part #B8272 for nylon tubing) is required with each bushing to make an oil tight connection.

To assemble a tubing connection, the compression bushing is first slipped over the end of the 5/32" tubing (metal or nylon), followed by a suitable compression sleeve. As the bushing is threaded to the female threaded connection, the sleeve is permanently crimped to the tubing, simultaneously making a reusable oil tight connection.

### When to Use Compression Nuts

Compression nuts (part #B1095) are used to make oil tight connections at the following:

- + Resistance fittings: meter units (FSA, FJB) and control units (CSA, CJB)
- + Male connections (5/16-24 NF): typically lubricator outlets and adapters

A compression sleeve (part #B1061 for metal tubing or part #B8272 for nylon tubing) is required with each nut to make an oil tight connection. The assembly technique is similar to that of compression bushings.

Use proper fittings because the system is under pressure during operation and leak-free connections are essential to prevent leakage and system pressure drop.

Bearing mounted resistance fittings (Types FSA and CSA) utilize a compression nut to provide a convenient and reusable connection for replacement of resistance fittings (see Figure 7.3).

A compression bushing is necessary when mounting a resistance fitting directly at the bearing with a tee adapter (see Figure 7.4).

All junction block connections utilize a compression bushing that help ensure tight tubing connections to junctions and that easily adapt to machine contours (see Figure 7.5).

## Distribution Components

	Part #	Description
Tubing	brass, copper, steel or nylon	5/32"
	brass, copper, steel or nylon	3/32"
Tubing clips	A2425	Single
	B3539	Double
Flexible Hoses	B3134	6"
	B3433	8"
	B3145	10"
	B3135	12"
	B3530	14"
Junctions	B3288	2-Way (2 outlets)
	B3065	3-Way
Junction-Single	B4231	4-Way
	B3262	4-Way Single (4 outlets)
	B3263	5-Way Single
Junction-Double	B3264	6-Way Single
	B3109	6-Way Double (6 outlets)
	B3253	8-Way Double
Closure Plug	B3254	10-Way Double
	B3784	
Connectors	A3920	Straight
	A2768	90° Elbow
	B3133	45° Elbow
Adapters	A2835	Straight
	A3080	90° Elbow
Compression Sleeve	B1061	Metal -5/32 Tubing
	B8272	Nylon
Compression Bushing	B1371	5/32 Tubing
Compression Nut	B1095	
	B3841	30 psi
Pressure Gauges	B5611	100 psi
	B4582	200 psi
	B7239	25µ (3 ")
Filters	B7254	25µ (5 ")

# Installation & Mounting

## Helpful Hint

Additional technical information about SLR lubricators and components are available at [www.bijurdelimon.com](http://www.bijurdelimon.com).

The information contained in Bijur Delimon's datasheets will help ensure trouble-free system operation and a long life for your equipment.

## Need Help?

Are you in doubt about any part of designing, specifying or ordering your Bijur Delimon SLR system? For help, copy your Bill of Materials checklist and send it to your Bijur Delimon sales representative.

## Sample Bill of Materials

Qty	Part #	Description
1	D3174	LSP-R Lubricator
4	B1084	FSA-1
1	B2495	FJB-0
1	B1072	FTA-1
2	B1107	FTD-1
1	B2761	FTG-1
1	B3065	Junction
1	B3264	Junction
2	B3784	Plug
1	B3530	Hose Assembly
4	A2768	Elbow
6	A2435	Clip
24	5B25	5/32" Tubing
6	B1095	Nut
20	B1371	Bushing
26	B1061	Sleeve

## Installation Tips

Be sure to mount the lubricator in an accessible area so the reservoir may be replenished with oil without stopping the machine or endangering the operator.

Always run main distribution lines as straight as possible along the contours of the machinery to be lubricated. Avoid sharp bends and moving equipment.

Keep branch and secondary lines as short as possible by placing junctions close to any lubrication point clusters.

## Ordering Tips

To assist in identifying system components, a Bill of Materials checklist has been provided (see opposite page). Fill in your final selections in the Bill of Materials as you complete each section of this brochure.

Upon completing the Bill of Materials you will be able to specify the necessary items and order your Bijur Delimon Single Line Resistance System.

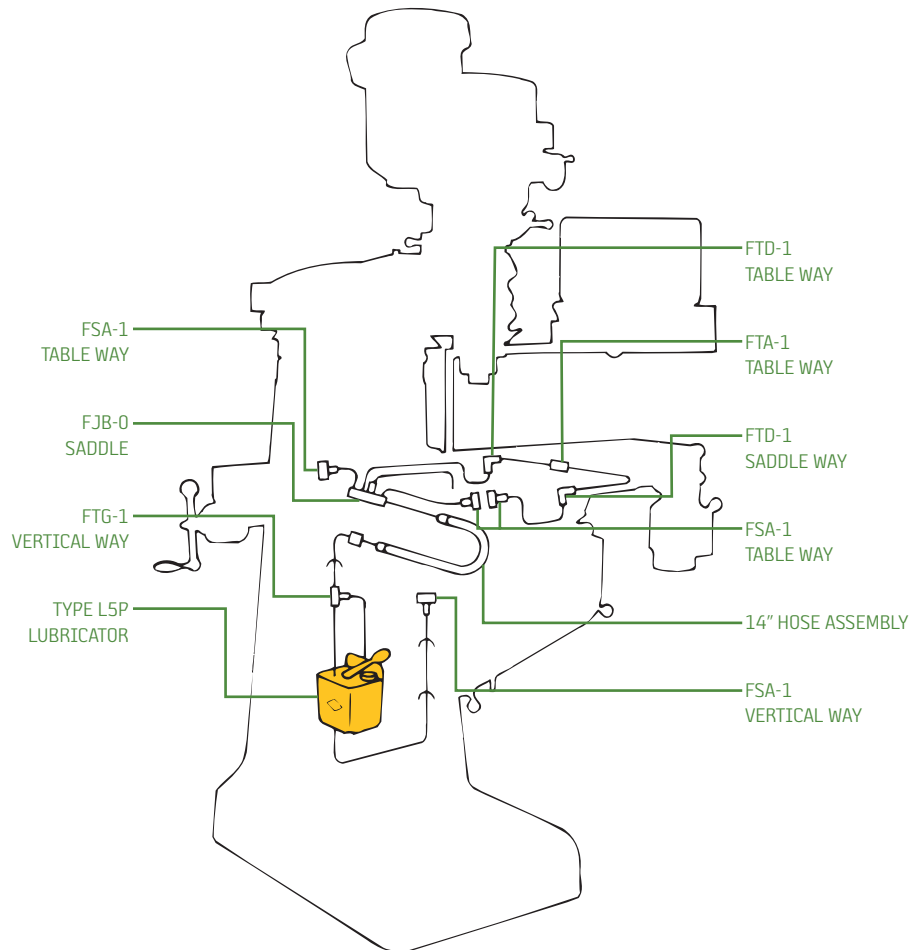

# Bill of Materials

Equipment type \_\_\_\_\_ Manufacturer \_\_\_\_\_ Model number \_\_\_\_\_

## System Type

<input type="checkbox"/> Cyclic (Manual)	Total # of lubrication points: ____				
<input type="checkbox"/> Cyclic (Automatic)	<b>Enter points per type:</b>				
<input type="checkbox"/> Cyclic (Automatic)	____ anti-friction	____ cam	____ cylindrical	____ gears	____ roller
	____ ball bearing	____ chain	____ flat	____ plain	____ slides/way

## System Types

<b>Check only one lubricator</b> ▶	<b>Manual</b>	<b>Automatic</b>	<b>Automatic Continuous</b>
	<input type="checkbox"/> L2P	<input type="checkbox"/> AA	<input type="checkbox"/> A0
	<input type="checkbox"/> L5P	<input type="checkbox"/> AB	<input type="checkbox"/> V5B
	<input type="checkbox"/> L18P	<input type="checkbox"/> TM-1	<input type="checkbox"/> V5C
	<input type="checkbox"/> HAP-P	<input type="checkbox"/> TM-5	<input type="checkbox"/> V5W
	<input type="checkbox"/> HIP-P	<input type="checkbox"/> TMD-5	<input type="checkbox"/> V3
	<input type="checkbox"/> KIB	<input type="checkbox"/> YP-8	<input type="checkbox"/> Gear Pump
	<input type="checkbox"/> KIC	<input type="checkbox"/> SureFire	

## Resistance Fittings

Quantity	Type	Flow Rating	<input checked="" type="checkbox"/> Choose from the following list for "Type" column:			
(e.g.) 4	FSA	1	<b>Manual &amp; Cyclic</b>		<b>Continuous</b>	
			<i>Straight:</i>	<i>Junction:</i>	<i>Straight:</i>	<i>Junction:</i>
			FSA	FJB	CSA	CJB
			FT	FJD	CT	CJD
			<i>Tee:</i>		<i>Tee:</i>	
			FTA		CTA	
			FTG		CTG	
			FTD		CTD	
<b>Total Quantity</b> (must equal total number of points)			See Brochure #151: Specialty Fluid Fittings for complete listing fittings.			

## Distribution Accessories

Description	Quantity	Description	Quantity
Tubing (circle one): copper, brass, steel or nylon	ft.	Compression Sleeves (circle one): metal or nylon	
Tubing Clips (circle one): single or double		Compression Bushings	
Flexible Tubing (specify length):		Compression Nuts	
Junctions (circle one): regular, single or double		Pressure Gauges (specify psi)	
Connectors (circle one): straight, 90° elbow or 45° elbow		Filters (specify size)	
Adapters (circle one): straight or 90° elbow			

## Innovators of engineered lubrication technology **since 1923**

Delimon International has ISO 9001:2000 and ISO 14000 quality certified manufacturing facilities around the world, so your centralized lubrication system meets the highest industry quality standards. It's all part of our commitment to quality and customer service.



### GLOBAL HEADQUARTERS

Bijur Delimon International  
2100 Gateway Centre Blvd., Suite 109  
Morrisville, NC 27560

(919) 465 4448 **LOCAL**  
(800) 631 0168 **TOLL-FREE**  
(919) 465 0516 **FAX**

[WWW.BIJURDELIMON.COM](http://WWW.BIJURDELIMON.COM)

258 • 08/09