

Universal Analog Input Configurable Trip Amplifier with display

DAT 5028

FEATURES

- Universal Analog Input
- Relay Outputs: 2 SPDT + 2 SPST (version with 4 thresholds)
- Relay Outputs: 2 SPDT (version with 2 thresholds)
- 1 V/mA Analog Output for signal transmission
- 1500 Vca galvanic isolation on all ways
- High Accuracy
- EMC compliance – CE Mark
- DIN rail suitable mounting (EN-50022)

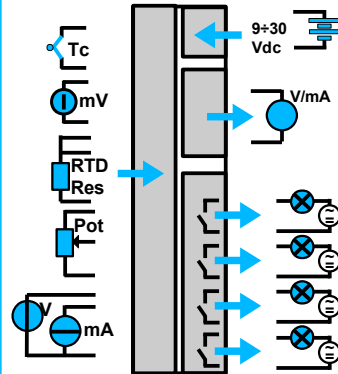

GENERAL DESCRIPTION

The DAT 5028 device is able to acquire RTD or Tc sensors, mV, V or mA input signals connected to the universal analog input. By means of push-button and 4-digit display on the front panel, four different trip alarms are configurable. Each alarm threshold commands an output relay. Input signal can be retransmitted on the analog output in a Voltage or Current signal, configurable by means of dip-switch on the side of the device.

By means of an internal 16 bit converter, the device guarantee a high accuracy and a stable measure versus time and temperature.

The 1500 Vac isolation on all ways removes eventual ground-loop effects, allowing the use of the device even in the heavy environmental conditions.

In function of the number of thresholds necessary to the user, the device can be supplied in two different versions:

DAT5028-4 with 4 thresholds (2 SPDT + 2 SPST);

DAT5028-2 con with 2 thresholds (2 SPDT).

DAT 5028 is in compliance with the Directive 2004/108/EC on the electromagnetic compatibility.

The device is housed in a rough self-extinguishing plastic container which, thanks to its thin profile of 22.5mm only, allows a high density mounting on EN-50022 standard DIN rail.

USER INSTRUCTIONS

Before to install the device, please read the "Installation Instruction" section. Connect power supply, analog input, relay outputs and analog output as shown in the "Wiring" section.

In normal conditions, the display must always show a value.

To simplify handling or replacing of the device, it is possible to change configuration or remove the wired terminals even with the device powered.

TRIP OPERATION MODE

The relay goes on when the input signal is higher than the set-point level for at least the delay time "t on" (mS). The relay goes off only when the input signal is lower than the hysteresis value for at least delay time.

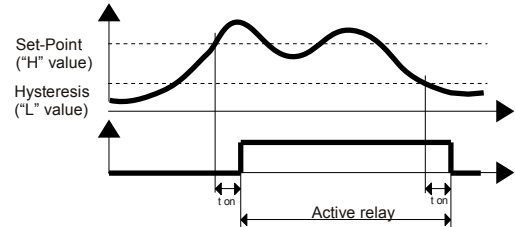

TECHNICAL SPECIFICATIONS (Typical @ 25 °C and in the nominal conditions)

Analog Inputs

Type	Range	Accuracy	Linearity	Thermal Drift
100 mV	-100 / +100 mV	±0.05 % f.s.	±0.1 % f.s.	100 ppm/°C
10 V	-10 / +10 V	±0.05 % f.s.	±0.1 % f.s.	100 ppm/°C
20 mA	0 / 20 mA	±0.05 % f.s.	±0.1 % f.s.	100 ppm/°C
Pt100	-200 / +850 °C	±0.05 % f.s.	±0.1 % f.s.	100 ppm/°C
Pt1K	-200 / +200 °C	±0.05 % f.s.	±0.1 % f.s.	100 ppm/°C
Ni100	-60 / +180°C	±0.05 % f.s.	±0.1 % f.s.	100 ppm/°C
Ni1K	-60 / +150 °C	±0.05 % f.s.	±0.1 % f.s.	100 ppm/°C
Res	0 / 2 Kohm	±0.05 % f.s.	±0.1 % f.s.	100 ppm/°C
Pot	0 / 100 %	±0.05 % f.s.	±0.1 % f.s.	100 ppm/°C
Tc J	-210 / +1200 °C	±0.05 % f.s.	±0.1 % f.s.	100 ppm/°C
Tc K	-210 / +1370 °C	±0.05 % f.s.	±0.1 % f.s.	100 ppm/°C
Tc R	-50 / +1760 °C	±0.05 % f.s.	±0.1 % f.s.	100 ppm/°C
Tc S	-50 / +1760 °C	±0.05 % f.s.	±0.1 % f.s.	100 ppm/°C
Tc B	+400 / +1825 C	±0.05 % f.s.	±0.1 % f.s.	100 ppm/°C
Tc E	-210 / +1000 °C	±0.05 % f.s.	±0.1 % f.s.	100 ppm/°C
Tc T	-210 / +400 °C	±0.05 % f.s.	±0.1 % f.s.	100 ppm/°C
Tc N	-210 / +1300 °C	±0.05 % f.s.	±0.1 % f.s.	100 ppm/°C

Lead wire res. influence RTD (3 wires) 0.05 %/Ω (50 Ω max)
mV, Tc < 0.8 uV/Ohm

Excitation current Pot, Res, Pot ~ 0.7 mA
Pot. Nominal value 2 KOhm
Sample Time 1 sec.
Warm-up time 3 min.

Digital Outputs

n.2 SPDT + n.2 SPST Relays
Max Load (resistive)

2 A @ 250 Vac (per contact)
2 A @ 30 Vdc (per contact)

Min Load

5Vdc , 10mA

Max Voltage

250Vac (50 / 60 Hz) , 110Vdc

Dielectric strength between contacts

1000 Vac, 50 Hz, 1 min.

Dielectric strength between coil and contacts

4000 Vac, 50 Hz, 1 min.

Analog Output

Type	Range	Accuracy	Linearity	Thermal Drift
10 V	0 / +10 V	±0.1 % f.s.	±0.05 % f.s.	100 ppm/°C
20 mA	0 / +20 mA	±0.1 % f.s.	±0.05 % f.s.	100 ppm/°C

Load Resistance

< 500 Ohm (current output)

Auxiliary Voltage

> 5 KOhm (voltage output)
>12V

Power Supply

Supply Voltage
Current consumption @ 24 Vdc
Rev. Polarity protection

12 + 30 Vdc
120 mA typ (200 mA max.)
60 Vdc max

Isolations

Isolation voltage 1500 Vac (on all ways)

EMC (for industrial environments)

Immunity EN 61000-6-2
Emission EN 61000-6-4

Temperature & Humidity

Operative temperature -30°C .. +60°C
Storage temperature -40°C .. +85°C
Relative humidity (not cond.) 0 .. 90 %

Housing

Material Self-extinguishing plastic
Mounting DIN rail EN-50022
Weight about 150 g.

CONFIGURATION BY DIP-SWITCHES

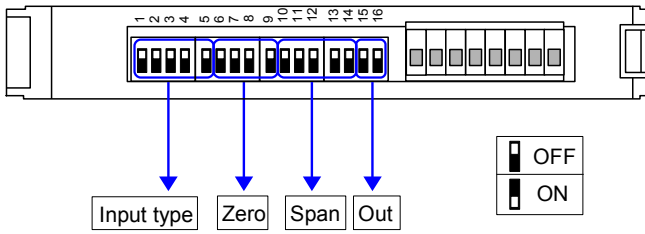

- 1) Set the input type by the dip-switch [1..5] (see TAB.1)
- 2) Set the minimum input scale value (Zero) by the dip-switch [6..9] (see TAB.2 *)
- 2) Set the maximum input value (Span) by the dip-switch [10..14] (see TAB.2 *)
- 4) Set the output type by the dip-switch [15..16] (see TAB.3)

* Refer to the proper input type range. Needed only if Analog Out retransmission is used.

TAB.1 – Input Type

1 2 3 4 5	Default	1 2 3 4 5	Res. 500Ω
1 2 3 4 5	100 mV	1 2 3 4 5	Pt 100
1 2 3 4 5	10 V	1 2 3 4 5	Pt 1K
1 2 3 4 5	20 mA	1 2 3 4 5	Ni 100
1 2 3 4 5	Tc J	1 2 3 4 5	Ni 1K
1 2 3 4 5	Tc K	1 2 3 4 5	Pot.
1 2 3 4 5	Tc R	1 2 3 4 5	1 V
1 2 3 4 5	Tc S		
1 2 3 4 5	Tc T		
1 2 3 4 5	Tc B		
1 2 3 4 5	Tc E		
1 2 3 4 5	Tc N		

TAB.3 - Out

15 16	0-20 mA
15 16	4-20 mA
15 16	0-10 V
15 16	0-5 V

TAB.2 – Input Range

Range selection for Res.

Zero	Span	Span
0 1 2 3 4	0 1 2 3 4	0 1 2 3 4
°C	°C	°C
Def.	Def.	170
0	0	180
10	10	190
20	20	200
30	30	250
40	40	300
50	50	400
75	60	500
100	70	700
125	80	800
150	90	900
175	100	1000
200	120	1300
225	140	1500
250	150	1700
300	160	1850

Range selection for Tc, RTD

Zero	Span	Span
0 1 2 3 4	0 1 2 3 4	0 1 2 3 4
°C	°C	°C
Def.	Def.	170
-200	0	180
-100	10	190
-80	20	200
-60	30	250
-50	40	300
-40	50	400
-30	60	500
-20	70	700
-10	80	800
0	90	900
10	100	1000
20	120	1300
50	140	1500
100	150	1700
150	160	1850

Range selection for 100mV

Zero	Span	Span
0 1 2 3 4	0 1 2 3 4	0 1 2 3 4
mV	mV	mV
Def.	Def.	17
-20	0	18
-10	1	19
-8	2	20
-6	3	25
-5	4	30
-4	5	40
-3	6	50
-2	7	70
-1	8	80
0	9	90
1	10	100
2	12	
5	14	
10	15	
15	16	

Range selection for mA

Zero	Span	Span
0 1 2 3 4	0 1 2 3 4	0 1 2 3 4
mA	mA	mA
Def.	Def.	13.0
0	5	13.5
1.5	5.5	14.0
2.0	6.0	15.0
2.5	6.5	15.5
3.0	7.0	16.0
3.5	7.5	16.5
4.0	8.0	17.0
4.5	8.5	17.5
5.0	9.0	18.0
5.5	10.0	18.5
6.0	10.5	19.0
6.5	11.0	19.5
7.0	11.5	20.0
7.5	12.0	20.0
8.0	12.5	20.0

Range selection for Pot.

Zero	Span	Span
0 1 2 3 4	0 1 2 3 4	0 1 2 3 4
%	%	%
Def.	Def.	80
0	5	85
15	10	90
20	15	95
25	20	100
30	25	
35	30	
40	35	
45	40	
50	45	
55	50	
60	55	
65	60	
70	65	
75	70	
80	75	

Range selection for 10 V

Zero	Span	Span
0 1 2 3 4	0 1 2 3 4	0 1 2 3 4
V	V	V
Def.	Def.	1.7
-2.0	0	1.8
-1.0	0.1	1.9
-0.8	0.2	2.0
-0.6	0.3	2.5
-0.5	0.4	3.0
-0.4	0.5	4.0
-0.3	0.6	5.0
-0.2	0.7	7.0
-0.1	0.8	8.0
0	0.9	9.0
0.1	1.0	10.0
0.2	1.2	
0.5	1.4	
1.0	1.5	
1.5	1.6	

CONFIGURATION OVERVIEW

The configuration of the device, can be controlled by means of the push buttons and the 4-digit display on the front side of the device.

In normal operation, the display shows the actual value of the analog input. To enter in the view mode, follow the next procedure:

- 1) press the "ESC" button : it will be displayed the label "In "
- 2) press the "ESC" button again, it will be displayed the input type value (see tab.4).
- 3) Keep to press the "ESC" button to visualize all of the setting values of the device (follow the next list):

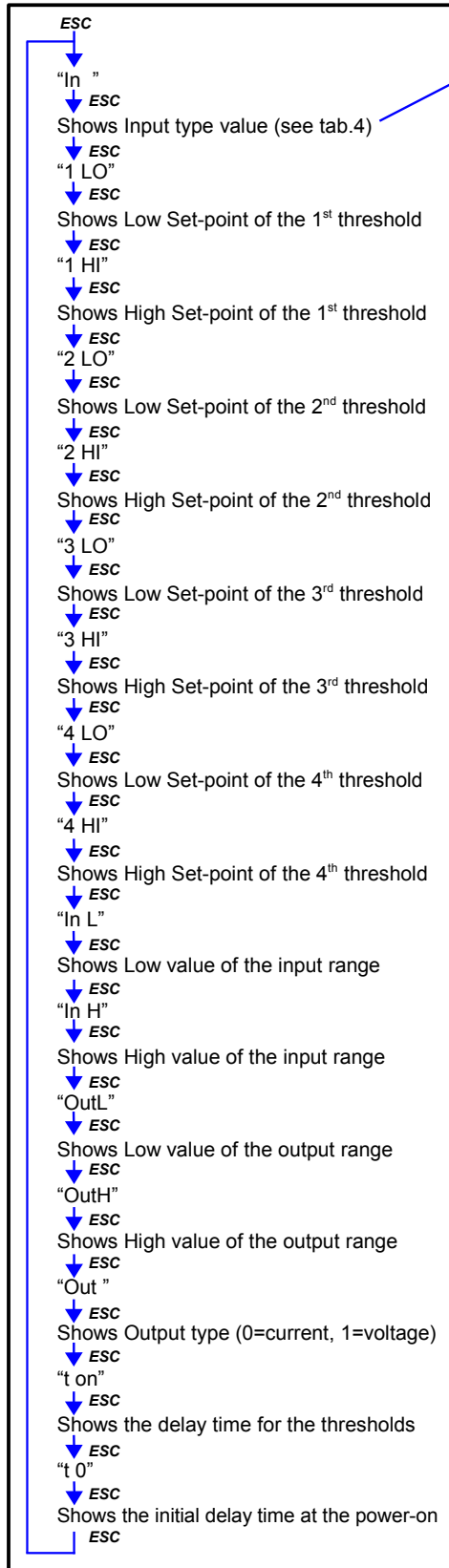

TAB.4 – Input Type

100 mV	1
10 V	2
20 mA	3
Tc J	4
Tc K	5
Tc R	6
Tc S	7
Tc T	8
Tc B	9
Tc E	10
Tc N	11
Res	12
Pt 100	13
Pt 1K	14
Ni 100	15
Ni 1K	16
Pot	17

THRESHOLD CONFIGURATION

To configure the threshold values press both the buttons ("SET"+"ESC") for at least 5 seconds.

- 1) Press the button "ESC" to scroll through to the list until the desired parameter to be configured appears.
- 2) Press the button "SET" to confirm the selection of the parameter; the display shows the value currently programmed.
- 3) Press the button "UP" or "DOWN" to modify the value: keeping pressed the button "UP" or "DOWN" to increase the speed of variation of the numbers.
- 4) When the desired value has been reached press both the buttons for at least 4 seconds. Don't press any button for 5 second to discard the changes.

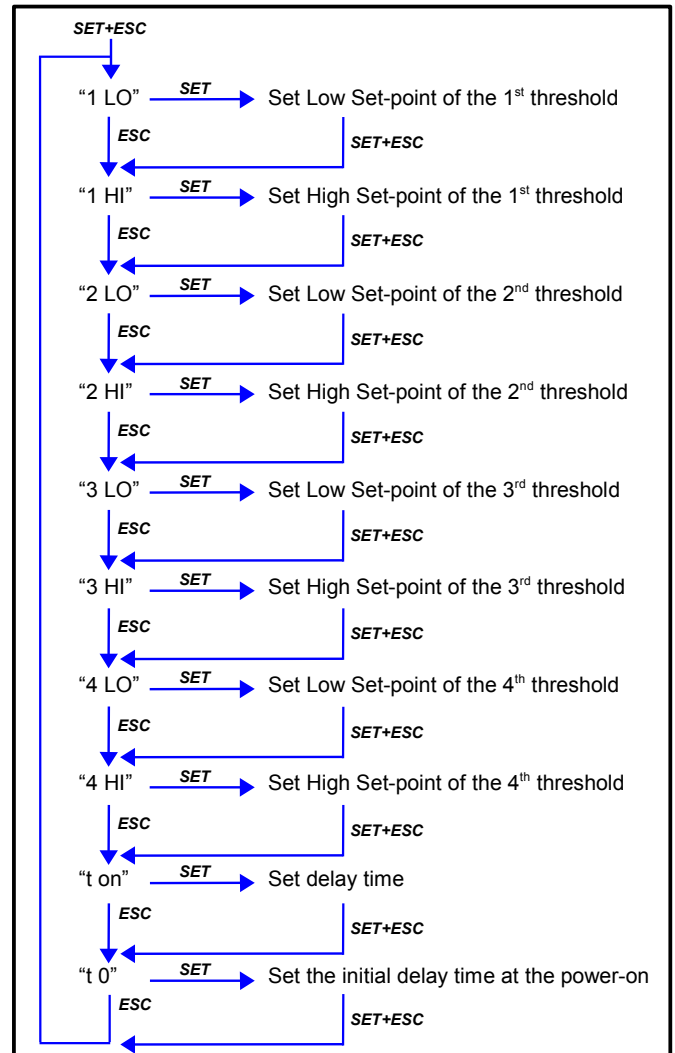

- 5) Repeat the step from 1 up to 4 for each parameter to configure. To exit from the threshold configuration don't press any button for 5 second: the device will automatically visualize the actual input measure in function of the programming performed.

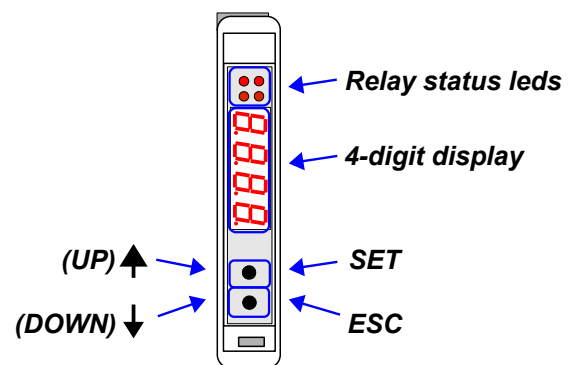

- 4) To exit from the view mode don't press any button for 5 second: the device will automatically visualize the actual input measure.

WIRING

ANALOG INPUT

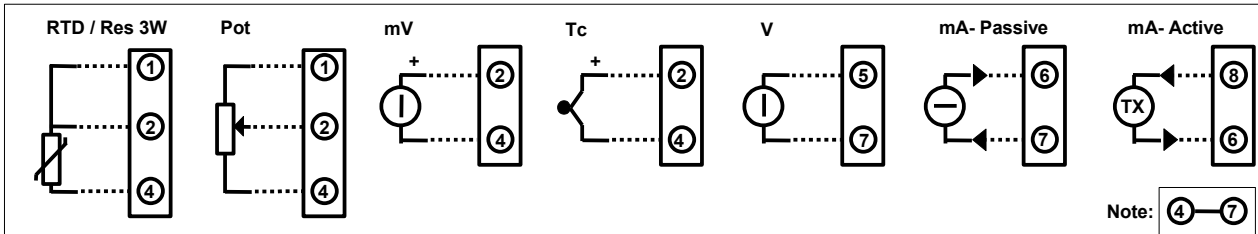

SUPPLY

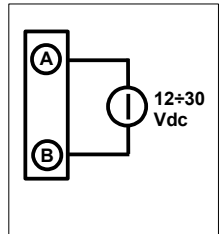

RELAY OUTPUT

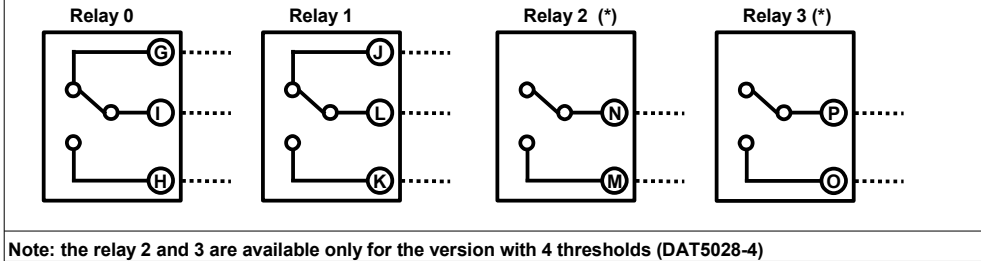

ISOLATIONS

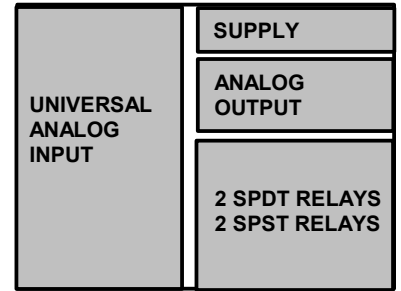

ANALOG OUTPUT

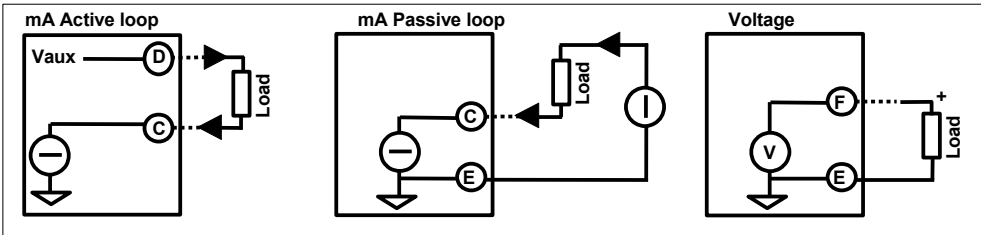

INSTALLATION INSTRUCTIONS

The device is suitable for fitting to DIN rails in the vertical position. For optimum operation and long life follow these instructions:

When the devices are installed side by side it may be necessary to separate them by at least 5 mm in the following case:

- If panel temperature exceeds 45°C and at least one of the overload conditions exist.

Make sure that sufficient air flow is provided for the device avoiding to place raceways or other objects which could obstruct the ventilation slits. Moreover it is suggested to avoid that devices are mounted above appliances generating heat; their ideal place should be in the lower part of the panel.

Install the device in a place without vibrations.

Moreover it is suggested to avoid routing conductors near power signal cables (motors, induction ovens, inverters etc...) and to use shielded cable for connecting signals.

LIGHT SIGNALLING

LED	COLOR	STATE	DESCRIPTION
Rn	RED	ON	Relay [n] excited
		OFF	Relay [n] released

HOW TO ORDER

DAT 5028 can be supplied with the configuration specified by the customer. It is necessary to specify the number of necessary thresholds (2 or 4). Refer to the "Technical Specification" section for the output type available.

ORDER CODE EXAMPLE:

DAT 5028 - 2

Number of thresholds : DAT 5028-2 (2 SPDT relay)
DAT 5028-4 (2 SPDT relay + 2 SPST relay)

- = Requested
- = Optional

MECHANICAL DIMENSIONS (mm)

