



General information
about using BJB products



Technology for Light
Components · Optics · Automation

General information and notes about using BJB products

Index

General information

General information, notes and definition of technical icons	4
Technical information for embodiment of our products	11
Properties of materials used for BJB products	12
Cable Information	13
Stripping and releasing of cables	14
Types of protection against dust and water in accordance with VDE and IEC regulations (extract)	15

Information for product categories

LED	19
Linear Fluorescent Lampholders: General Applications	20
Linear Fluorescent Lampholders: Water and Dustproof	23
Compact Fluorescent Lampholders	27
HID Lampholders	31
Terminal blocks and Connectors	35
Line Voltage Halogen Lampholders	39
Low Voltage Halogen Lampholders	40
Incandescent Lampholders	43

BJB worldwide	48
----------------------	-----------



General
information



General information, notes and definition of technical icons

All articles in this catalogue have been designed according to the appropriate national and international standards (VDE / IEC).

The choice of product and correct technical embodiment is the sole responsibility of the user.

Further information on request. We reserve the right to modify products.

Maximum rated operating temperature t_c

This indicates the maximum permissible temperature which can occur on the external surface of the LED module (measurement point generally marked with t_c) under normal operating conditions and at rated voltage / current / power or the maximum value of rated voltage range / current range / power range.

Explanation of the symbols shown on the product pages

	Temperature rating The maximum operating temperature is given by a T marking according to IEC. This is the maximum continuous operating temperature for which the lampholder is designed. Additional information may be given for the rear of the lampholder (i.e., T_m 110° C).		Quad push wire terminals
	Temperature rating The maximum operating temperature is given by a T marking according to IEC. This is the maximum continuous operating temperature for which the lampholder is designed. Additional information may be given for the rear of the lampholder (i.e., T_m 110° C).		Screw terminals
	Temperature rating This is the maximum operating temperature for the rear of the lampholder.		Tab terminal for electrical connection and/or earthing
	Temperature rating The maximum operating temperature is given by a T marking according to IEC. This is the maximum continuous operating temperature for which the lampholder is designed. Additional information may be given for the rear of the lampholder (i.e., T_m 110° C).		Stripped length Stripped length in mm
	Temperature rating Declaration of the minimum and maximum permissible environmental temperatures according to IEC 60998 / VDE 0613, parts 1 and 2		For solid conductors within the cross sectional range stated (In this example 0.5 - 1.0 mm ²) When regulations deviate from IEC, other cross sections are possible (e.g. UL / CSA: cable 18 AWG).
	Temperature rating Temperature index according to UL		For tinned wire ends within the cross sectional range stated When regulations deviate from IEC, other cross sections are possible (e.g. UL / CSA: cable 18 AWG).
	Single push wire terminals		For wire ends with ferrule to the maximum diameter stated (In this example max. ø 1.8 mm) The cable and termination used must be compatible in respect of: Diameter and length of the ferrule, strip length of insulation. For further information see DIN 46228, part 3, size 1 - 7 Material and surface of ferrules have to correspond to the relevant application. For temperatures > 200°C we recommend ferrules of steel, nickel plated.
	Twin push wire terminals		

General information, notes and definition of technical icons

	For 7 stranded wire ends within the cross sectional range stated (In this example 1.8 mm ²)		Rating
	For fine-stranded conductor within the cross sectional range stated		Rating SELV converter required
	Wire ends with ferrule		Rating Indication of rated values. For approval cULus (USA).
	Wire ends with tab terminals as per nominal size stated.		Rating Indication of rated values. For approval cULus (USA).
	Material thickness Indication in mm (In this example 0.5 - 1.3 mm)		Rating Rated voltage 500V for the application with electronic mains ballasts having an output voltage U_{out} up to 500V.
	Rating Declaration of rated voltage in volts and rated current in Amps.		Rating Declaration of power and colour temperature.
	Rating Declaration of rated voltage in volts and rated current in Amps.		Starting voltage Declaration of the maximum starting voltage.
	Rating Indication of rated values. For approval PSE (Japan).		Rated impulse voltage Rated impulse voltage (U_{imp}) indicates the peak value, to which the component can be used without failure.

General information, notes and definition of technical icons

	Protection class according to IEC		Light Distribution Curve - Double Asymmetrical
	Protection class according to IEC		Light Distribution Curve - Single Asymmetrical (Left)
	LED-C-Line LED Connector		Light Distribution Curve - Single Asymmetrical (Right)
	LED-L-Line LED Lampholder		Lamp/Module fitted with LED
	LED-SMD-Line SMD part		Lamp fitted with special E26 bulb Lamp fitted with bulb as per wattage, cap and nominal voltage stated
	Light Distribution Curve available		Lamp fitted with special E14 bulb Lamp fitted with bulb as per wattage, cap and nominal voltage stated
	Light Distribution Curve - Narrow Beam		Lamp fitted with special G4 bulb Lamp fitted with bulb as per wattage, cap and nominal voltage stated
	Light Distribution Curve - Wide Beam		Lamp fitted with special G9 bulb Lamp fitted with bulb as per wattage, cap and nominal voltage stated

General information, notes and definition of technical icons

	Lampholder for Instant Start		Zhaga certified
	Top Test - for efficient final testing of lighting fixtures Our trademark „Top Test“ refers to two test ports located in the top of the lampholder. The electrodes of the Top Test adaptor are inserted here to connect with the internal contacts of the lampholder, allowing a fast final circuit test without the need for test lamp insertion and removal.		CAD-Data in 2D or 3D format available
	Front Test - for efficient final testing of lighting fixtures. In principal this method is the same as Top Test, except that the adapter electrodes are inserted into the rotor from the front.		Additional information Further information about the products shown on this page can be found on the pages shown within this symbol.
	Automatic final testing of light fitting		
	Airpass-Rotor Manufactured from a highly heat resistant material, the airpass rotor provides point contact with the lamp cap, resulting in an air gap between the face of the lampholder and the lamp cap. This allows heat dissipation, resulting in the lampholder operating at a lower temperature. This simple but effective rotor system has proven itself over more than a decade in millions of applications.		
	90° rotor lock		
	Lean Form The lampholders have an extremely thin form, resulting in: - better thermal conditions, e.g. for cables; - assembly advantages due to increased room for routing cables - improved and cost effective assembly due to new assembly method possibilities.		
	Lamp for self-cleaning ovens The lamp was matched to the special requirements of self-cleaning ovens. E.g., special lenses made from borosilicate glass are available. However, the oven manufacturer must test the suitability themselves, as the construction characteristics of different oven models and the embodiment position can affect the lamp.		

Technical information for embodiment of our products

BJB lampholders are in accordance with IEC regulations and are designed to IEC 60061-2 publication.

Where no electrical data is stated then:

- according to IEC 60238 / VDE 0616 part 1, Edison lampholders E14 rated 250 V / 2 A conform to overload capacity category II, E27 rated 250 V / 4 A voltage and E40 conform to voltage overload capacity category III ,
- according to IEC 60400 / VDE 0616 part 3 fluorescent lampholders and starter holders rated 250 V / 2 A conform to voltage overload capacity category II,
- Halogen lampholders designed according to IEC 60838 / VDE 0616 part 5, conform to voltage overload capacity category II,
- Bayonet lampholders according to the requirements IEC 61184 / VDE 0616 part 2 conform to voltage overload capacity category II,
- Lampholder outer threads conform to IEC 60399
- LED modules according to EN 62031

When regulations deviate from IEC, e.g. UL, other ratings may be possible. Please consult us before use.

Through our work with the relevant standardisation committees, we ensure our lampholders are developed and tested to the latest specifications.

All technical product drawings shown in this catalogue indicate only the main important dimensions and tolerance values. As a rule only where this is of importance for the intended application.

All measurements stated without tolerances are nominal.

Limit values are:

- DIN 16901, size 130 for moulded parts
- DIN ISO 2768-m for metal parts
- DIN 40680, medium for ceramic parts

Weights of single items stated in this catalogue are rounded up or rounded down to the nearest gram, therefore the final weight of a pack quantity may differ. The weights shown are only a guide and should not be used for order or shipping specification purposes.

The choice of product and correct technical embodiment in accordance with the corresponding regulations (e.g. IEC 60598 / VDE 0711, IEC 60335 / VDE 0700) is the sole responsibility of the user.

Specific attention must be given to:

- Temperature limits which must be observed in accordance with the corresponding regulations (e. g. T-markings);
- The necessary creepage and clearance distances as well as distances through insulation;
- The connecting cable and wires, which must have the correct heat and UV resistance, mechanical strength, voltage rating and a current carrying capacity corresponding to the conditions of the intended application;
- Protection against contact with live parts; Connectors, e.g. tab terminals, which must be selected in accordance with the requirements of their intended use (e.g. temperature, current carrying capacity, corrosion resistance);
- The influence of control gear, transformers, starters / ignitors and other circuit components, must always be taken into consideration.

The catalogue also contains technical information, to which attention must be paid during project development, construction and electrical installation or when operating lighting installations. This information must be passed on, e.g. in an installation instruction. To ensure snap fix products locate correctly and securely, consideration must also be given to the cut-out and where applicable, attention must be paid to special requirements (e.g. degree of burr, direction of punching, radii, etc.).

Consideration must also be given to the area required around the cut-out, to allow correct insertion. Different components may require to be inserted at different angles.

During fixing, it must be ensured that the fixing surface is correctly sized.

Information regarding light fitting wall thickness, should always be interpreted as inclusive of a coating, unless stated otherwise.

If there is a requirement for one of our products to be embodied in a way other than shown in our catalogue, please contact us.

Attention must also be given to the IEC lamp standards, as well as the technical instructions of the lamp manufacturers in respect of the embodiment and correct operation of lamp.

Our oven lamps are exclusively designed for embodiment within domestic appliances. They are not suitable to be used for general ambient lighting.

When LED modules are connected in series, creepage and clearance distances must be observed in accordance with the overall voltage.

When using TIM films and ceramic COBs, we recommend types with a thickness of 0 - 0.2mm. The hardness of the TIM film should be min. 70 Shore A. Softer and / or thicker TIM films, as well as phase change materials, can lead to functional disturbances and is the responsibility of the user.

New technologies have been introduced into the market by so called retrofit lamps; their masses exceed the weights of the original lamps in some cases by a multiple. For their use in already installed luminaires and lamp holders as well as for newly designed luminaires an increased risk of mechanical damage or a release of the connection can be expected. Examples of particularly vulnerable systems are those that do not provide separation between the mechanical retention forces and the electrical contact-making. With these the retention forces are provided solely via the contact forces.

In accordance with our policy of continual product development and improvement, we reserve the right to make design modifications.

Due to the amount of information involved in compiling this catalogue, it is not always possible to avoid printer's errors or minor mistakes. Although every care is taken, BJB accepts no responsibility for the accuracy of the contents. If in doubt, or if you require confirmation of specific information, please contact us.

Properties of materials used for BJB products

Note:

In applications the chemical resistance is dependent on many parameters, therefore this data can only be considered as recommended value.

Assessment of the suitability of BJB products for a concrete application is the responsibility of the customer and, where appropriate, should be verified by means of tests under operating conditions.

The selection and correct technical application of BJB products is the responsibility of the customer.

Thermoplastic materials

Thermal properties	Thermoplastic								
	PC	PMMA	PBT	PET	PA	POM	PPA	PPS	LCP
permissible continuous thermal stress in °C to the IEC and UL standards	up to 110°C	80° C / 90° C	up to 180°C	up to 210°C	120°C*	ca. 85°C	125° C / 150° C	up to 250°C	up to 270°C

*Limited temperature according to IEC 60598

Chemical properties									
Weak acids	+	+/0	+/0	0	-	+	0	+	+
Strong acids	0/-	0/-	-	0/-	-	0/-	-	-	0
Weak alkalies	-	+	0	0	+	+	+	+	+
Strong alkalies	-	0/-	-	0/-	-	+/0	+/0	-	0/-
Strong alkalies	0/-	0/-	+	+/0	+/0	+	+	+/0	+/0
Alcohol	-	-	-	0/-	+	0	+	0	+
Esters	-	-	0	0/-	+	+/0	+	0	0
Ether	-		+	0	+	+	+	+/0	
Hydrocarbon chloride	-		+/-	0/-	+/0	+	+/0	0	
Benzol	-	-	0/-	+	+	0	+	0	
Cleaning benzin (aroma free)	+	+	+	+	+	+	+	+	+
Fuel mixes	0/-	0	+	+/0	+	+	+	+	+/0
Mineral oils	+/0	+	+	+	+	+	+	+	+
Animal and vegetable oils	+	+	+	+	+	+	+	+	+

+ = resistant 0 = limited resistance - = not resistant

Information on material for gaskets of waterproof lampholders for fluorescent lamps

Type	Oil resistance	Resistance to ozone- and weather	Continuous operating temperature	Resistance to chemicals
CR [Chloropren- /Chlorbutadien Rubber]	good	good	100°C	good
EPDM [Ethylen-Propylen-Dien-Copolymerisat Rubber]	moderate	good	130°C	good
Silicon [Methyl-Vinyl-Polysiloxan]	fairly good	good	220°C	good
SBR [Styrol-Butadien-Rubber]	moderate	fairly good	80°C	good-fairly good

Cable Information

Technical properties

Properties	Insulation material					
	PVC	PE-X (PE meshed)	Silicone	FEP	PTFE, PFA	Fibreglass
Conductor material						
	Cu/Cu tin plated	Cu/Cu tin plated	Cu tin plated	Cu tin plated	Cu nickel plated	Nickel or Cu with 27% nickel plated
Temperature resistance						
	-30°C - +105°C	-40°C - +105°C	-60°C - +180°C	-100°C - +180°C	-190°C - +250°C	-60°C - +450°C
Thermal resistance	-	+	+	+	++	+++
Electrical strength	0	++	++	+++	+++	++
Mechanical strength	0	++	-	++	++	++
Chemical resistance	-	+	+	++	++	++
Notched charpy impact strength	-	+	-	+	+	++
Fracture strength, abrasion resistance	-	+	0	+	+	++
Abrasion	-	+	0	+	+	+
Flexibility	+	0	++	0	0	-
Weather-, ozone- and ageing resistance	0	+	+	+	+	+
Not inflammable	0	+	-	+	+	++
Halogen free	-	++	+	-	-	+
Light resistant (also UV)	-	+	0	+	+	+
Pyrolysis	-	+	-	-	-	+
Price	++	-	+	0	-	--
Applicability for ignition voltage	0	0	++	+	+	++
Usual characteristics (examples)						
Nominal cross section	0.5 mm ²	0.5 mm ²	0.75 mm ²		1.0 mm ²	0.5 mm ²
Outer diameter	2 mm	1.75 mm	2.4 mm	1.6-1.8 mm	1.8-2.0 mm	2.5 mm
Nominal voltage	300 V				300 / 600 V	

0 = adequate + = good ++ = better +++ = very good - = bad -- = very bad

In applications these properties are dependent on many parameters, therefore this data can only be considered as recommended value.

Comparison of AWG cross sections to metric cross sections for multi stranded, fine stranded and finest stranded wires

AWG	ca. mm ²
24	0.2
23	0.34
22	0.35
20	0.5
19	0.75
18	1
16	1.5
14	2.5
12	4
10	6

Stripping and releasing of cables

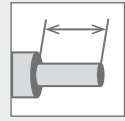

Icon

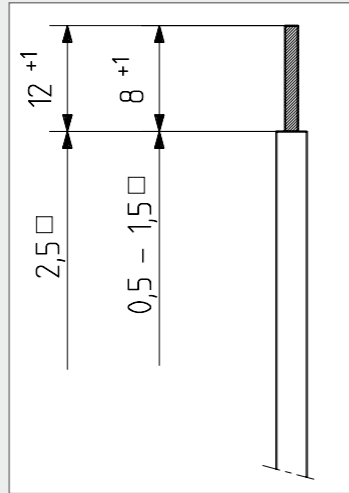

Stripping of conductors

Pushwire contacts for solid core and tinned wires:

0.5 - 1.5 mm² = 8 + 1,0 mm
2.5 mm² = 12 + 1.0 mm

Should other terminations or stripped length need to be used e.g. ferrules, you will find the relevant information in the product description.

Methods of releasing wires

Pushwire contacts with a key or oval hole in the housing:
The release probe, which we can gladly provide upon request, is placed behind the conducting wire, thereby opening the leaf spring. The wire can be pulled out.
(when pressing the leaf spring down, extreme care must be taken in order that the contact does not become distorted)*.

Simplest way:
Pull out the release probe and the wire at the same time.

Pushwire contacts with a round hole or release slot in the housing:
A release probe or screwdriver is inserted into the release slot and a slight pressure applied to the leaf spring (when pressing the leaf spring down, extreme care must be taken in order that the contact does not become distorted)*.
The wire is easily removed.

* Under light fitting production conditions, we recommend not to use unassembled lampholders again.

Types of protection against dust and water in accordance with VDE and IEC regulations (extract)

The types of protection for electrical products e.g. protection against foreign bodies, dust and water, are stated in the VDE standards and relevant publications issued by the IEC. For full details see IEC 60529 from which the following is an extract.

Symbol for luminaires according to IEC 60598	Type of protection according to IEC	Abbreviation according to IEC	Brief details of the degrees of protection	
			1st digit: protection against foreign bodies	2nd digit: protection against water
No symbol	Ordinary	IP 20	Fingers or similar objects not exceeding 80 mm in length. Solid objects exceeding 12 mm in diameter.	No special protection.
	Drip proof	IP 21	Fingers or similar objects not exceeding 80 mm in length. Solid objects exceeding 12 mm in diameter.	Dripping water (vertically falling drops) shall have no harmful effect.
	Rain proof	IP 23	Fingers or similar objects not exceeding 80 mm in length. Solid objects exceeding 12 mm in diameter.	Water falling as a spray at an angle up to 60° from the vertical shall have no harmful effect.
No symbol	Protected against solid objects greater than 1.0 mm	IP 40	Wires or strips of thickness greater than 1.0 mm. Solid objects exceeding 1.0 mm in diameter.	No special protection.
	Splash proof	IP 44	Wires or strips of thickness greater than 1.0 mm. Solid objects exceeding 1.0 mm in diameter.	Water splashed against the enclosure from any direction shall have no harmful effect.
	Dust proof	IP 50	Ingress of dust is not totally prevented but does not enter in sufficient quantity to interfere with satisfactory operation of the equipment.	No special protection.
	Dust and rain proof	IP 53	Ingress of dust is not totally prevented but does not enter in sufficient quantity to interfere with satisfactory operation of the equipment.	Water falling as a spray at an angle up to 60° from the vertical shall have no harmful effect.
	Dust and splash proof	IP 54	Ingress of dust is not totally prevented but does not enter in sufficient quantity to interfere with satisfactory operation of the equipment.	Water splashed against the enclosure from any direction shall have no harmful effect.
	Dust tight and jet proof	IP 65	No ingress of dust.	Water projected by a nozzle against the enclosure from any direction shall have no harmful effect.
	Dust tight and water tight (immersible)	IP 67	No ingress of dust.	Ingress of water in a harmful quantity shall not be possible when the enclosure is immersed in water under defined conditions of pressure and time.

Information for
product categories



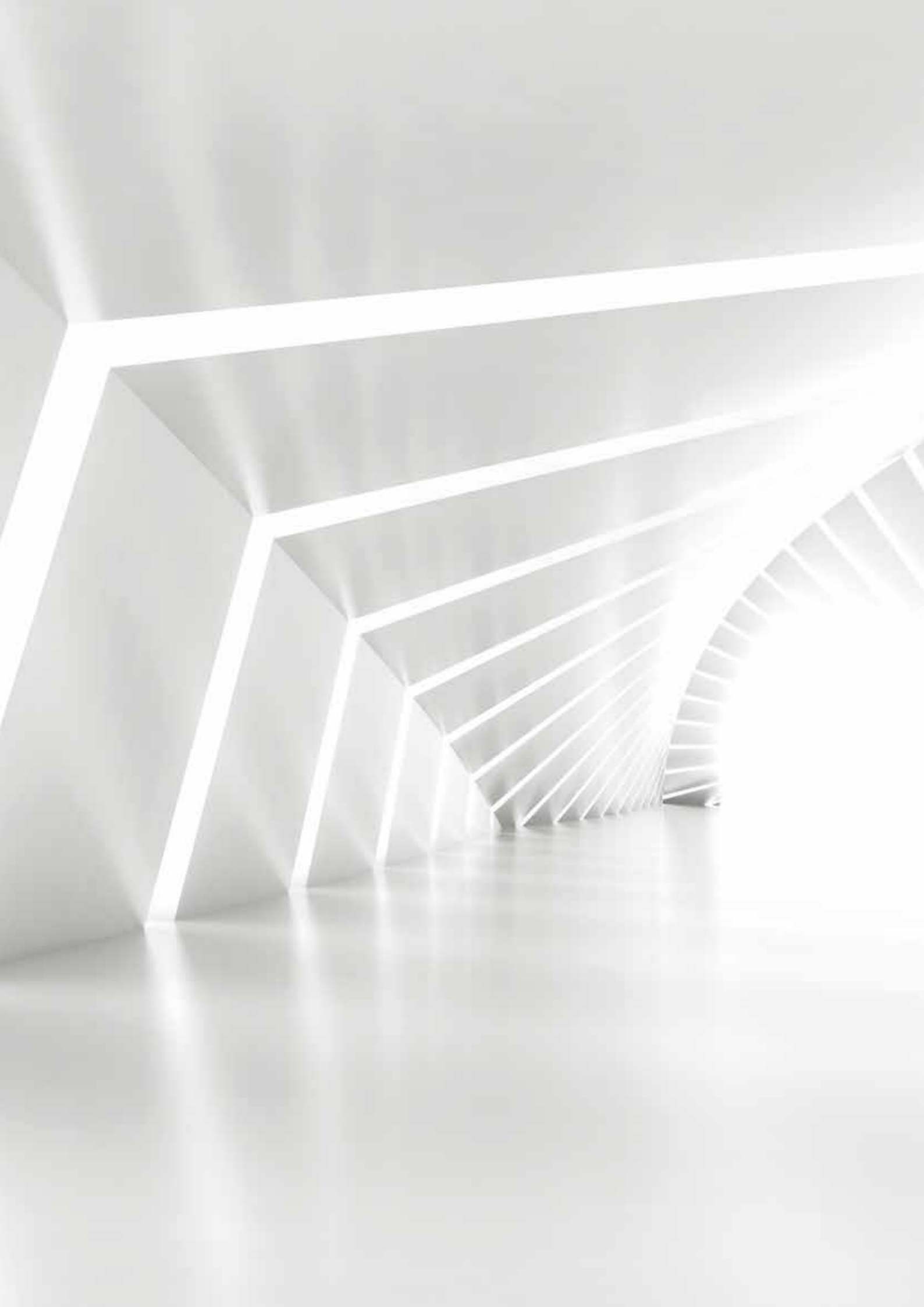

LED

Information and notes for products of the categories below, you will find at our website at www.bjb.com:

- SMD Terminal blocks
- Connectors for COBs
- Linear Flat System (LFS)
- Push2Fix (P2F) - Fixing Elements
- Optics
- Terminal blocks and Connectors
- LED modules BJB Discus
- Lampholders for LED Modules
- More Components

Lampholders and starter holders for fluorescent lamps

Technical information

Where no electrical rating is stated then, fluorescent lampholders and starter holders are designed for 250 V / 2 A and G5 lampholders for 500 V / 2A according to IEC 60400 / VDE 0616 part 3. When regulations deviate from IEC, e.g. UL, other ratings are possible.
Rotor fixing 90° - G13 lampholders with rotor have a 90° rotor fixing unless otherwise stated.

The information and values stated here are for quick reference only. For specific information please contact the relevant lamp manufacturer. * For linear tubular fluorescent lamps the maximum angle of displacement for a pair of lampholders is 3°.	Wattage - W -	total length L1 max. - mm -	tube diameter - d - - mm -	* Lampbase / standard	Lampholder / standard

G13							
	15	437.4	26.0	G13	G13		
	16	720.0	26.0				
	18	589.8	26.0				
	30	894.6	26.0				
	36	970.0/1199.4	26.0				
	38	1047.0	26.0				
	58	1500.0	26.0	G13	G13		
	70	1763.8	26.0				
	20	589.8	38.0			G13	G13
	25	970.0	38.0				
	30	894.6	38.0				
	40	1199.4	38.0				
65	1500.0	38.0					
75	1763.8	38.0					
100	2374.3	38.0					

G5					
	4	135.9	16.0	G5	G5
	6	212.1	16.0		
	8	288.3	16.0		
	13	516.9	16.0		
	14	549.0	16.0		
	21	849.0	16.0		
	24	549.0	16.0		
	28	1149.0	16.0		
	35	1449.0	16.0		
	39	849.0	16.0		
	54	1149.0	16.0		
	80	1449.0	16.0		

Lampholders and starter holders for fluorescent lamps

Technical information

The information and values stated here are for quick reference only. For specific information please contact the relevant lamp manufacturer.

* For linear tubular fluorescent lamps the maximum angle of displacement for a pair of lampholders is 3°.

W4.3 x 8.5d	Wattage - W -	total length L1 max. - mm -	tube diameter - d - - mm -	* Lampbase / standard	Lampholder / standard
	6	219.3	7.0	W4.3 x 8.5d	W4.3 x 8.5d
	8	320.9	7.0		
	11	422.5	7.0		
	13	524.1	7.0		
				IEC 60061-1 7004-115	IEC 60061-2 7005-115

RX17d	Wattage - W -	total length L1 max. - mm -	tube diameter - d - - mm -	* Lampbase / standard	Lampholder / standard
	84	2367.0	25.5	RX17d	RX17d

2GX13	Wattage - W -	total length L1 max. - mm -	tube diameter - d - - mm -	* Lampbase / standard	Lampholder / standard
	22	225.0	16.0	2GX13	2GX13
	40	300.0	16.0		
	55	300.0	16.0		
	60	367.0	16.0		

Water and dustproof lampholders

Technical information - Protection tubes

The lampholders will generally be delivered without assembled foot gasket.
 Where no electrical rating is stated then, fluorescent lampholders and starter holders are designed for 250 V / 2 A, according to IEC 60400 / VDE 0616 part 3.
 When regulations deviate from IEC, e.g. UL, other ratings may be possible.

Information and values stated here are for quick reference only.

Lamp wattage - W -	Lamp length L1 max. - mm -	Length of protection tube L - mm -
-----------------------	----------------------------------	---

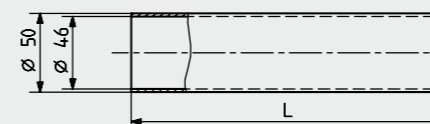

G13	Lamp length L1 max. - mm -	Length of protection tube L - mm -
20	589.8	560
40	1199.4	1170
65	1500.0	1470

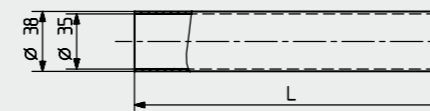

G13	Lamp length L1 max. - mm -	Length of protection tube L - mm -
18	589.8	556
36	1199.4	1166
58	1500.0	1466

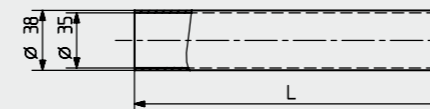

G5	Lamp length L1 max. - mm -	Length of protection tube L - mm -
21	849.0	815
35	1449.0	1415
54	1149.0	1115

Lampholders for compact fluorescent lamps

Technical information

Where no electrical rating is stated then, fluorescent lampholders and starter holders are designed for 250 V / 2 A and G5 lampholders for 500 V / 2A according to IEC 60400 / VDE 0616 part 3. When regulations deviate from IEC, e.g. UL, other ratings are possible.

	Wattage - W -	Lamp length - mm -		Lamp base/ standard	Lampholder/ standard	
		L1	L			
			L (d)			L (q)
G23 	5 7 9 11	85 115 145 215	108 138 168 238	G23 IEC 60061-1 7004-69	G23 IEC 60061-2 7005-69	
G24 	10 13 18 26	95 130 150 170	118 153 173 193	G24 IEC 60061-1 7004-78	G24 IEC 60061-2 7005-78	
GX24 	13 18 26 32 42 57 70	90 105 125 140 155 181 165,5	113 128 148 156 171 197 208	GX24 IEC 60061-1 7004-78	GX24 IEC 60061-2 7005-78	

Lampholders for compact fluorescent lamps

Technical information

The information and values stated here are for quick reference only. For specific information please contact the relevant lamp manufacturer.

Wattage - W -	Lamp length - mm -		Lamp base/ standard	Lampholder/ standard
	L1	L		

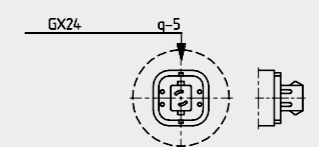
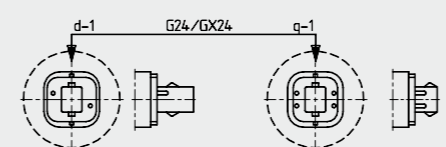

Lamp base G24 and GX24
Key d-1 / q-1, 10 - 13 W
Key q-5, 57 W

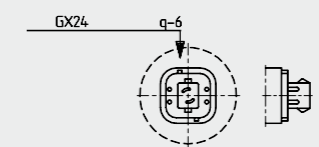
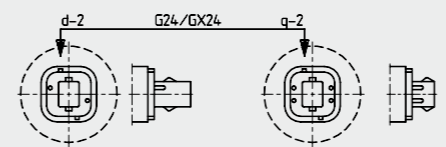

Lamp base G24 and GX24
Key d-2 / q-2, 18 W
Key q-6, 70 W

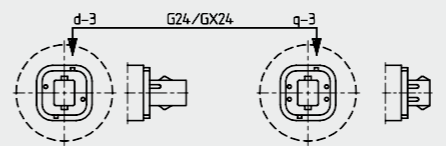

Lamp base G24 and GX24
Key d-3 / q-3, 26 and 32 W

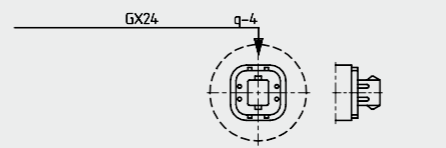

Lamp base G24 and GX24
Key q-4, 42 W

2G7	5 7 9 11		85 115 145 215	2G7 IEC 60061-1 7004-102	2G7 IEC 60061-2 7005-102
-----	-------------------	--	-------------------------	--	--

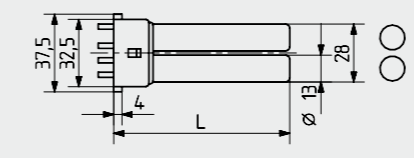

2GX7	13		157	2GX7 IEC 60061-1 7004-103	2GX7 IEC 60061-2 7005-103
------	----	--	-----	---	---

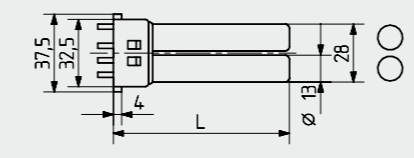

Lampholders for compact fluorescent lamps

Technical information

	Wattage - W -	Lamp length - mm -		Lamp base/ standard	Lampholder/ standard
		L1	L		
<p>The information and values stated here are for quick reference only. For specific information please contact the relevant lamp manufacturer.</p>					
2G11 	18 24 36 40 55		225 320 415 535 535	2G11 IEC 60061-1 7004-82	2G11 IEC 60061-2 7005-82
2G10 	18 24 36		122 165 217	2G10 IEC 60061-1 7004-118	2G10 IEC 60061-2 7005-118
GR10q 	10 16 21 28 38	92 138 138 205 205	95 141 141 207 207	GR10q IEC 60061-1 7004-77	GR10q IEC 60061-2 7005-77
GX53 	7			GX53	GX53



Lampholders for discharge lamps

Technical information

Standard dimensions for base and lampholders are contained in IEC 60061, in so far as available. Our declarations about the lampholders correspond to IEC 60838 standard. Different terms are also defined therein (e.g. lampholder / connecting elements etc). Exact information can be obtained upon request. We reserve the right to modify products. Through our work with the relevant national standardisation committees, we ensure our lampholders are developed and tested to the latest available specifications.

When embodying the lampholders, contact protection as well as creepage and clearance distance to live parts must be considered. Regulations in respect of ignition voltages are also to be observed.

Technical information for HID lampholders:

Cables and tab terminals must be suitable for the conditions of the intended application. To ensure the correct distance between contacts, RX7s lampholder bodies must be fixed.

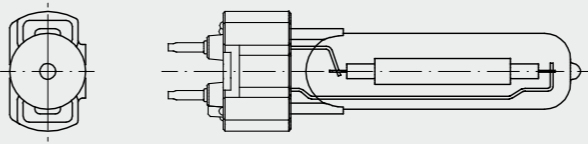
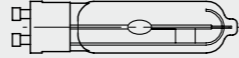
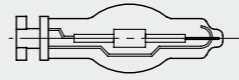
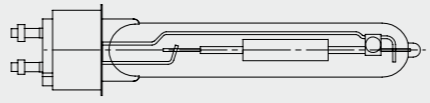
The information and values stated here are for quick reference only. For specific information please contact the relevant lamp manufacturer.	Wattage - W -	Lamp base/ standard	Lampholder/ standard
GX12-1 	50 100	GX12-1 IEC 60061-1 7004-135	GX12-1 IEC 60061-2 7005-135
GU6.5 	20 35	GU6.5 IEC 60061-1 7004-21	GU6.5 IEC 60061-2 7005-20
PGJ5 	20 35	PGJ5 IEC 60061-1 7004-24	PGJ5 IEC 60061-2 7005-20
PGZ12 	45 60 90 140	PGZ12 IEC 60061-1 7004-21A	PGZ12 IEC 60061-2 7005-20

Lampholders for discharge lamps

Technical information

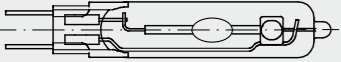
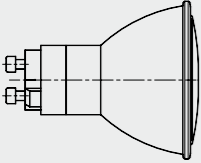
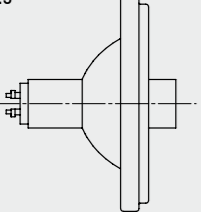
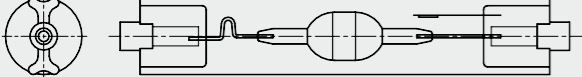
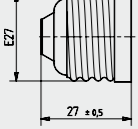
The information and values stated here are for quick reference only. For specific information please contact the relevant lamp manufacturer.	Wattage - W -	Lamp base/ standard	Lamp base/ standard
G8.5 	20 35 70	G8.5 IEC 60061-1 7004-122	G8.5 IEC 60061-2 7004-122
GX10 	35	GX10	GX10
GX8.5 	38 70	GX8.5	GX8.5
RX7s 	70 (114,2 mm) 150 (132 mm)	RX7s IEC 60061-1 7004-92A	RX7s IEC 60061-2 7005-92A 7005-53 7005-53A
E27 		E27 IEC 60061-1 7004-21	E27 IEC 60061-2 7005-20

Lampholders for discharge lamps

Technical information

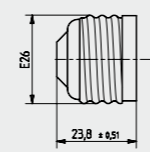
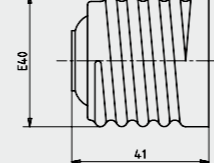
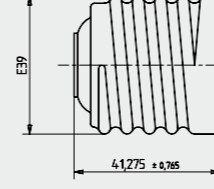
The information and values stated here are for quick reference only. For specific information please contact the relevant lamp manufacturer.	Wattage - W -	Lamp base/ standard	Lampholder/ standard
E26 		E26 IEC 60061-1 7004-21A	E26 IEC 60061-2 7005-20
E40 		E40 IEC 60061-1 7004-24	E40 IEC 60061-2 7005-20
E39 		E39 IEC 60061-1 7004-24A	E39 IEC 60061-2 7005-24A

Technical information

Terminal blocks Flat Connect (Rapid-Earth-Contact (REC))

Terminal blocks 46.433 - 46.435

The REC provides an electrical connection between the earth pole of the terminal block and the mounting plate also a mechanical connection is made in addition to the electrical connection.

Metalwork specification

Acceptable materials: All types of steel plate in common usage (Aluminium plate is not suitable, because the earth contacts are made of a copper alloy).

Permissible thickness: 0.5 - 1.0 mm

Surface: Must be protected against corrosion (e. g. steel plates may be plated, painted or plastic coated).

Cut-outs:

The cut-outs must correspond with the following drawing.

Rapid-Earth-Contact:

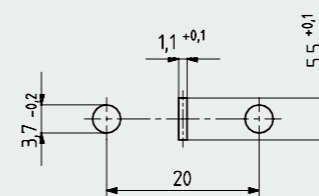

The diameter of the fixing holes allows for a finish to be applied.

The dimensions of the cut-out for the earth contact must correspond to those stated.

A maximum punching tolerance of 0.1 mm is permissible in the direction of insertion.

Approvals:

The terminal blocks are approved to EN 60998.

Embodiment

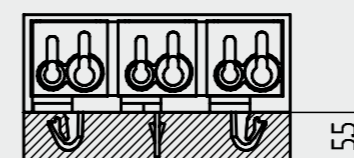

The risk of damage to the Rapid Earth Contact (see shaded area of drawing above) during production, packing, transport, assembly, as well as distribution of the light fittings must be eliminated by the method of construction.

For example:

- Assembly onto a separate component carrier inside the light fitting (e.g. bus)
- Increased construction
- Depressions or spacers in suitable positions and of a suitable size.

The design detail is therefore dependent on embodiment, metalwork stability and the specific production methods of the user. We recommend an agreement is made with the relevant testing facility.

Assembly

The terminal block must be inserted into the cut-out at right angles to the metalwork.

Pressure to snap in the terminal block should only be applied when correctly positioned above the cut-out.

Depending upon the construction of the fitting and the material used, it may be necessary to support the metalwork in the area of the cut-out during installation to eliminate the possibility of distortion, thus ensuring correct location and contact of REC.

Distortion of the snap in pins must be avoided. It must be ensured that the snap in pins as well as the REC have located correctly.

Testing

Once fully assembled, the light fitting must undergo a full electrical final test for earth continuity according to IEC IEC 60598.

Wiring may be inserted at an angle between 0° and 20° (optimal 10°)

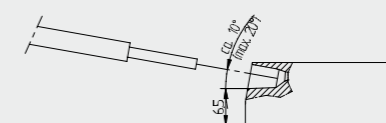

- Strip length
0.5 - 1.0 mm²: 8⁺¹ mm
2.5 mm²: 12⁺¹ mm

- Cable diameters:
External: 2 x 0.5 - 2.5 mm²

- Internal: a) 1 x 0.5 - 1.0 mm², releasable
b) 1 x 0.5 - 2.5 mm², releasable
c) Suppression capacitor:
1 x 0.5 - 0.75 mm², not releasable

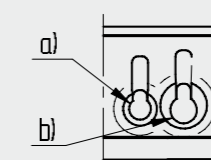

When embodying the terminal blocks, ensure sufficient space is allowed for connections to be made.

- The surrounding rim must lie flat.
- The cables must not exert any bending forces onto the terminal block contacts during connection.

To avoid exceeding the nominal currents steps must be taken during the design and installation of lighting systems to avoid operating conditions that require the terminal block to perform outside its design parameters.

Examples:

- Long lasting ignition procedures with resulting increase in current
- Non-symmetrical load distribution in three-phase lighting systems (compensation currents)
e. g. through

- Uneven number of light fittings per phase
- Lamp failures
- On and off switching of individual strands
- Failure of phases
- Upper waves of the operating currents can add up in the neutral wire.

Especially during installation of light strips or lighting groups, large current carrying capacity is achieved through sliding through of the wires.

Stripping the wire:

Push wire terminals for solid and tinned wire ends
Cables 0.5 - 1.0 mm²: 8⁺¹ mm
2.5 mm²: 12⁺¹ mm

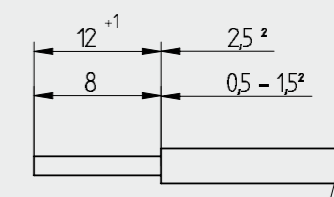

If other wire ends, e.g. wire end with ferrules are used, you will find information on product description side.

Wire release function:

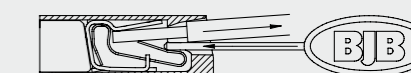

Terminal blocks with round holes and release slot in the housing or contact:
A wire release tool or screw driver is passed through the release slot, then a slight pressure is exerted on the contacts (care must be taken to carefully press down the clamping leg to avoid overstretching).

This makes it easy to loosen the wire.

Under lighting conditions, we recommend that you do not reuse disassembled terminals.

Technical information

Terminal blocks with earth contact (REC) 46.412 - 46.415

The REC provides an electrical connection between the earth pole of the terminal block and the mounting plate also a mechanical connection is made in addition to the electrical connection.

Metalwork specification

Acceptable materials: All types of steel plate in common usage (Aluminium plate is not suitable, because the earth contacts are made of a copper alloy).

Permissible thickness: 0.5 - 1.0 mm

Surface: Must be protected against corrosion (e. g. steel plates may be plated, painted or plastic coated).

Cut-outs

The cut-outs must correspond with the following drawing.

Rapid-Earth-Contact:

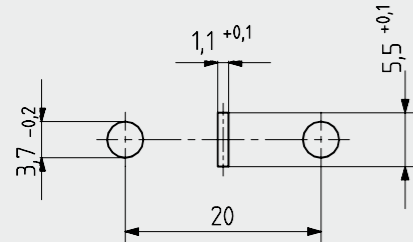

The diameter of the fixing holes allows for a finish to be applied.

The dimensions of the cut-out for the earth contact must correspond to those stated.

A maximum punching tolerance of 0.1 mm is permissible in the direction of insertion.

Approvals

The terminal blocks are approved to EN 60998.

Embodiment

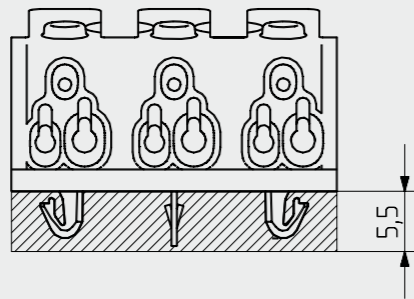

The risk of damage to the Rapid Earth Contact (see shaded area of drawing above) during production, packing, transport, assembly, as well as distribution of the light fittings must be eliminated by the method of construction.

For example:

- Assembly onto a separate component carrier inside the light fitting [e.g. bus]
- Increased construction
- Depressions or spacers in suitable positions and of a suitable size.

The design detail is therefore dependent on embodiment, metalwork stability and the specific production methods of the user. We recommend an agreement is made with the relevant testing facility.

Assembly

The terminal block must be inserted into the cut-out at right angles to the metalwork.

Pressure to snap in the terminal block should only be applied when correctly positioned above the cut-out.

Depending upon the construction of the fitting and the material used, it may be necessary to support the metalwork in the area of the cut-out during installation to eliminate the possibility of distortion, thus ensuring correct location and contact of REC.

Distortion of the snap in pins must be avoided.

It must be ensured that the snap in pins as well as the REC have located correctly.

Testing

Once fully assembled, the light fitting must undergo a full electrical final test for earth continuity according to IEC IEC 60598.

Technical information

Terminal blocks 46.412 - 46.415, Light fitting final testing

· Incoming mains supply cables can be released by depressing the lever above the contact.

· Wiring may be inserted at an angle between 0° and 20° (optimal 10°)

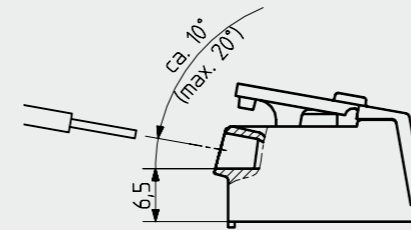

· Strip length
0.5 - 1.0 mm²: 8⁻¹ mm
1.5 - 2.5 mm²: 12⁻¹ mm
Suppression capacitor: 8±1 mm

· Cable diameters:
External: 2 x 0.5 - 2.5 mm² with release facility

Internal: a) 1 x 0.5 - 1.0 mm², releasable
b) 1 x 0.5 - 2.5 mm², releasable
c) Suppression capacitor:
1 x 0.5 - 0.75 mm², not releasable

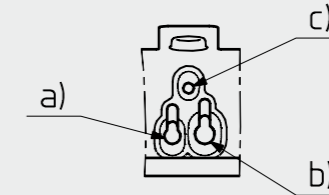

· When embodying the terminal blocks, ensure sufficient space is allowed for connections to be made.
· The surrounding rim must lie flat.
· The cables must not exert any bending forces onto the terminal block contacts during connection.

To avoid exceeding the nominal currents steps must be taken during the design and installation of lighting systems to avoid operating conditions that require the terminal block to perform outside its design parameters.

Examples:

- Long lasting ignition procedures with resulting increase in current
- Non-symmetrical load distribution in three-phase lighting systems (compensation currents)
e. g. through
 - Uneven number of light fittings per phase
 - Lamp failures
 - On and off switching of individual strands
 - Failure of phases

· Upper waves of the operating currents can add up in the neutral wire.

Especially during installation of light strips or lighting groups, large current carrying capacity is achieved through sliding through of the wires.

Automatic final testing

Test openings on the top of the terminal blocks (see drawing) make the insertion of a test adaptor possible. The electrodes of the adaptor meet the terminal block contacts, so that electronic test apparatus can measure the result. Please contact us for further details of the test adaptor. For a test movement vertical to the assembly surface, we recommend an electrode of max. \varnothing 1.8 mm.

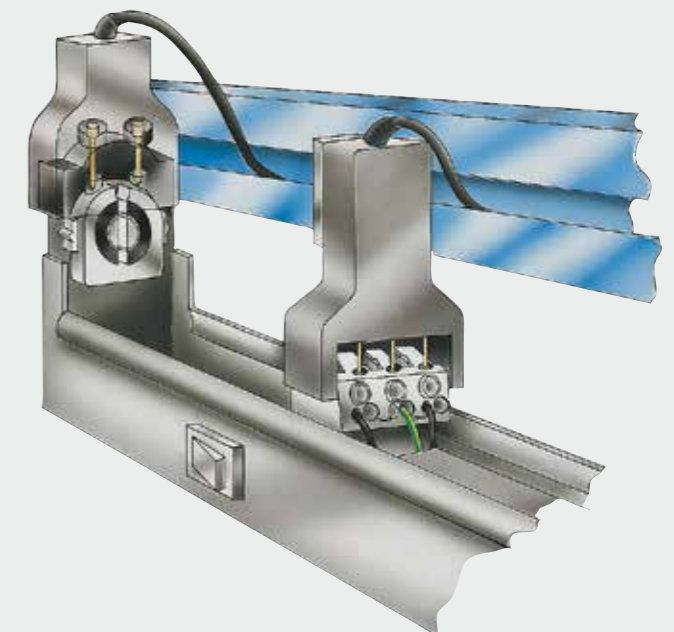
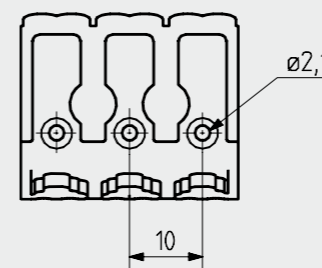

Lampholders for mains voltage halogen lamps

Technical information

The information and values stated here are for quick reference only. For specific information please contact the relevant lamp manufacturer.

When embodying the lampholders, contact protection as well as creepage and clearance distance to live parts must be considered.

Technical information for mains voltage halogen lampholders:
Cables and tab terminals must be suitable for the conditions of the intended application.
To ensure the correct distance between contacts, R7s lampholder bodies must be fixed.
Please also note the general information at the end of this catalogue and the directions for use.

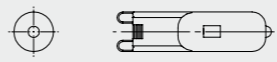
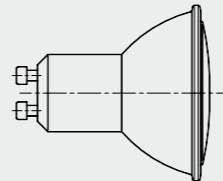
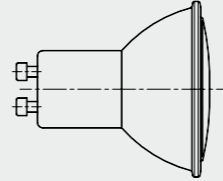
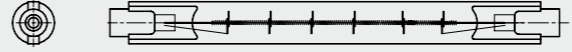
	Rating - W -	Lamp base/ standard	Lampholder/ standard
G9 	25 40 60 75	G9 IEC 60061-1 7004-129	G9 IEC 60061-2 7005-129
GU10 	35 50 75	GU10 IEC 60061-1 7004-121	GU10 IEC 60061-2 7005-121
GZ10 	50	GZ10 IEC 60061-1 7004-120	GZ10 IEC 60061-2 7005-120
R7s 	60 100 150 200 250 300 400 500 750 1000 1500 2000	R7s IEC 60061-1 7004-92	R7s IEC 60061-2 7005-53 7005-53A

Lampholders for low voltage halogen lamps

Technical information

The information and values stated here are for quick reference only. For specific information please contact the relevant lamp manufacturer. When embodying the lampholder, contact protection as well as creepage and clearance distance to live parts must be considered.	Rating - W -	Lamp base/ standard	Lamp pins ø mm	Lampholder/ standard

G4 	5 10 20	G4 IEC 60061-1 7004-72	0,65 - 0,75	G4 IEC 60061-2 7005-72

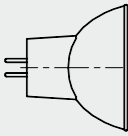
GZ4 	20 35	GZ4 IEC 60061-1 7004-67	0,95 - 1,05	GZ4 IEC 60061-2 7005-67

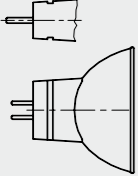
GU4 	10 20 35	GU4 IEC 60061-1 7004-108	0,95 - 1,05	GU4 IEC 60061-2 7005-108

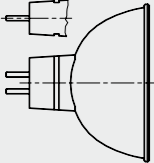
GU5.3 	20 35 50	GU5.3 IEC 60061-1 7004-109	1,45 - 1,60	GU5.3 IEC 60061-2 7005-109

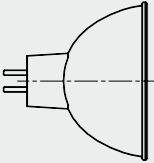
GX5.3 	20 35 50	GX5.3 IEC 60061-1 7004-73-A	1,45 - 1,60	GX5.3 IEC 60061-2 7005-73-A

Lampholders for low voltage halogen lamps

Technical information

The information and values stated here are for quick reference only. For specific information please contact the relevant lamp manufacturer. When embodying the lampholder, contact protection as well as creepage and clearance distance to live parts must be considered.	Wattage - W -	Lampbase / standard	Lamp pins ø mm	Lampholder / standard

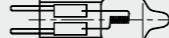
GY6.35 	20 35 50 65 75 90 100 150	GY6.35 IEC 60061-1 7004-59	1,20 - 1,30	GY6.35 IEC 60061-2 7005-59

Edison screw & Bayonet cap lampholders

Technical information

The information and values stated here are for quick reference only.
For specific information please contact the relevant lamp manufacturer.

Lampbase /
standard

Lampholder /
standard

E12

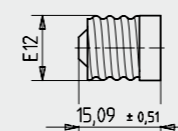

E12

IEC
60061-1
7004-28

E12

IEC
60061-2
7005-28

E14

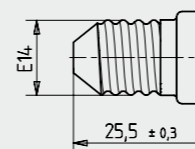

E14

IEC
60061-1
7004-23

E14

IEC
60061-2
7005-20

E17

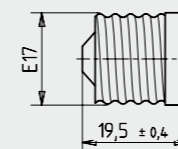

E17

IEC
60061-1
7004-26

E17

IEC
60061-2
7005-20

E26

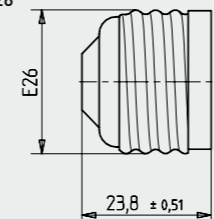

E26

IEC
60061-1
7004-21A

E26

IEC
60061-2
7005-20

E27

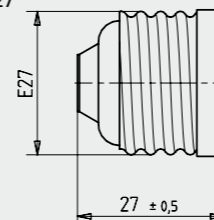

E27

IEC
60061-1
7004-21

E27

IEC
60061-2
7005-20

Edison screw & Bayonet cap lampholders

Technical information

The information and values stated here are for quick reference only. For specific information please contact the relevant lamp manufacturer.	Lampbase / standard	Lampholder / standard
---	------------------------	--------------------------

	B22d IEC 60061-1 7004-10	B22d IEC 60061-2 7005-10
--	--	--

Examples of application

Lampholders E12, E14, E17

	Fixing method	Lampholder
--	---------------	------------

Metal sheet		Push in fixing 22.225 22.228.3913 22.230 (not for 22.230.3346 and 22.230.3946) 22.231 22.233 22.243
-------------	--	--

Plastic		Push in fixing 22.225 22.228.3913 22.230 (not for 22.230.3346 and 22.230.3946) 22.231 22.233 22.243
---------	--	--

Plastic		Push in fixing 22.225 22.228.3913 22.233 22.243
---------	--	---

Metal sheet		Snap in fixing into housing cut-out 22.230 22.231 22.233 22.234 22.243
-------------	--	--

* Gap only for use with lampholder E17-22.233.3922.81

Plastic		Snap in fixing into housing cut-out 22.230 22.231 22.233 22.234 22.243
---------	--	--

* Gap only for use with lampholder E17-22.233.3922.81

Examples of application Lampholders E12, E14, E17

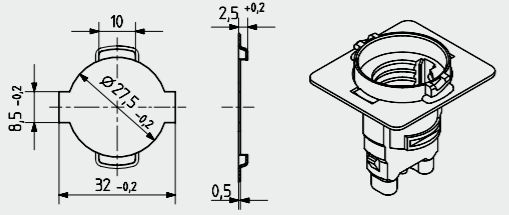
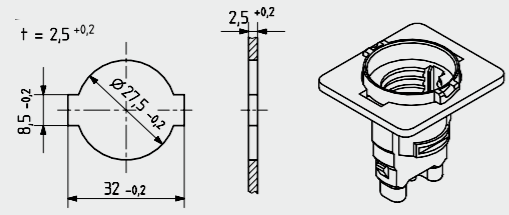
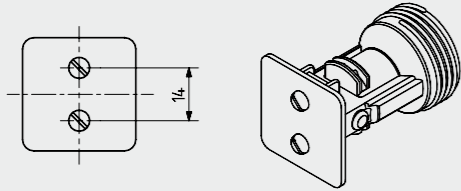
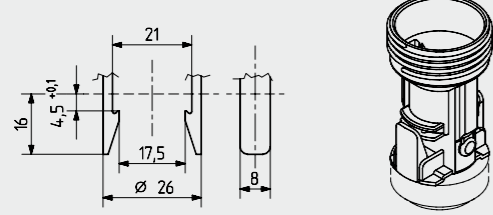
	Fixing method	Lampholder
Metal sheet 	Bayonet fixing	22.233 22.234 22.243
Plastic 	Bayonet fixing	22.233 22.234 22.243
	Screw fixing	22.223 22.225 22.228
	Snap in fixing	22.223 22.225 22.228

Examples of application Lampholders E26, E27

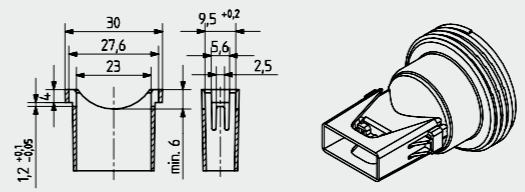
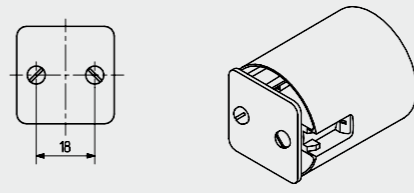
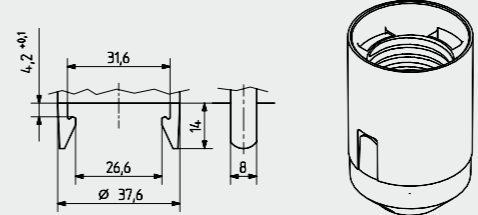
	Fixing method	Lampholder
Plastic 	Snap in fixing	22.328 - E27
	Screw fixing	22.317 - E26 22.317 - E27 22.318 - E26 22.318 - E27 22.347 - E26
	Snap in fixing	29.304 - E26 29.304 - E27 22.317 - E26 22.317 - E27 22.318 - E26 22.318 - E27 22.330 - E27 22.347 - E26

BJB worldwide

Headquarters BJB Germany

BJB GmbH & Co. KG
Werler Straße 1 . 59755 Arnsberg
Telephone +49 (0) 29 32.9 82-0
Telefax +49 (0) 29 32.9 82-8201
info@bjb.com . www.bjb.com

BJB China

BJB Electric Dongguan Ltd.
Guancheng High-Tech Park Five Road (North),
Eastern Industrial Zone,
JiangNanDaDao, Qishi Town,
Dongguan
China PC: 523512
Telefon +86 769 22766 891
Telefax +86 769 22766 895
bjbchina@bjb.com . www.bjb.com

BJB Hong Kong

BJB Hong Kong Ltd.
Suite 2508, Tower 1, Lippo Centre
89 Queensway
Hong Kong
Telephone +86 769 22766 891
Telefax +86 769 22766 896
bjbchina@bjb.com . www.bjb.com

BJB Japan

BJB Co.,Ltd.
4F-B El Dorado Yokohama
36-5, Chigasaki-chuo
Tsuzuki-ku, Yokohama
224-0032 Japan
Telephone +81 45 479 1110
Telefax +81 45 479 1115
sales-japan@bjb.com . www.bjb.com

BJB Spain

BJB Procesa S.A.
C-155 De Sabadell a Granollers, km 14,2
Apartado de Correos, 8
E-08185 Lliça de Vall (Barcelona)
Telephone +34 93/8445170
Telefax +34 93/8445184
procesa@bjb.com . www.bjb.com

BJB USA

BJB Electric L.P.
6375 Alabama Highway
Ringgold, GA 30736
USA
Telephone (706) 965-2526
Telefax (706) 965-2528
sales@bjb.com . www.bjb.com

Sales Office Brazil

Alexandre Lozano
Av. Miro Vetorazzo, 115 C. 80
09820-135 São B. do Campo - SP - Brasil
Telephone +55 1143961582
Mobile +55 11983475204
Telefax +49 2932 982 8384
alexandre.lozano@bjb.com . www.bjb.com

Sales Office Italy

Franz Steinkeller
Viale Famagosta, 61
I-20142 Milano
Telephone +39 02 36591513
Mobile +39 348 3056409
Telefax +39 029159029
franz.steinkeller@bjb.com . www.bjb.com

Sales Office Qatar

Garry Slater
Apartment 608 6th floor
Y Building 12 -Street 950
Zone 38
Al sadd - Doha
Qatar
Mobile: +974 6622 7810
Garry.Slater@bjb.com . www.bjb.com

Sales Office Ningbo

Ryan Hu
Room 1516
Liansheng Building (North Part)
Cultural and commercial District Cixi
315300 Ningbo - China
Mobile: +86 139 58286600
Ryan.Hu@bjb.com . www.bjb.com



Technology for Light

