



G003074

Manual Call Point IP23 Salwico MCP-A (GB)

Part no. 5200030-01A

System: Salwico Cargo, Salwico Cruise, Salwico Workboat,
Salwico Yacht, Salwico RoPax, CS3000, CS3004, CS4000

General Description

MCP-A is an addressable manual call point for indoor environment, designed for the Salwico addressable fire alarm systems.

Pressing the glass causing it to crack activates the fire alarm. A protective plastic coating on the glass prevents operator injury.

An LED on the front of the call point indicates the fire alarm. The LED remains lit until the fire alarm has been reset on the fire alarm panel.

The call point can be tested with a special key, included in the delivery.

The address of the call point is set with a DIP-switch.

The MCP-A provides short-circuit protection via connections 1–4 and no short-circuit protection via connections 5–8.

In order to achieve IP23 the MCP-A shall be mounted on a smooth surface and the cable inlet/outlet shall be secured against leakage.

Data

Nominal voltage	34 VDC
Working voltage	20-38 VDC
Supervising current	0.2 mA
Alarm current	2.5 mA
Ingress protection	IP23D
Temperature range	-25°C to +70°C
Ambient humidity	0 to 95% RH
Material	PC/ABS
Colour	Red, RAL 3001
Weight	~160 g
Cable dimension	Ø6-14 mm

Certified according to



Spare glasses (10pcs.)

Part no.
5200075-00A

Connection

Connection of this call point depends on its function in the fire alarm system. The different alternatives are illustrated below.

Connection with short-circuit protection



NOTE!

Connection with short-circuit protection is not applicable for system CS3000 or CS3004.

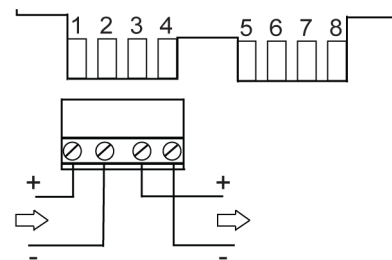

G003213

Figure 1. Connection with short-circuit protection for system Salwico Cargo, Salwico Cruise, Salwico Workboat, Salwico Yacht and Salwico RoPax

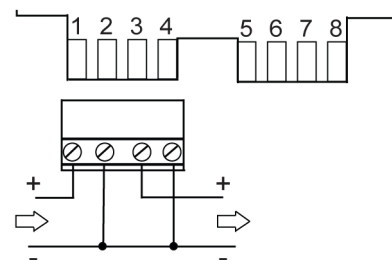

G003663

Figure 2. Connection with short-circuit protection for system CS4000

Connection without short-circuit protection

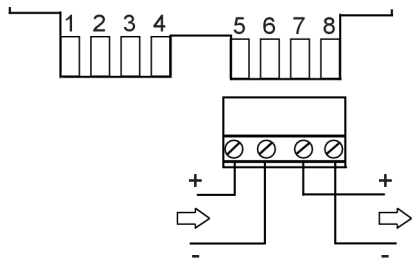

G003771

Figure 3. Connection without short-circuit protection for system Salwico Cargo, Salwico Cruise, Salwico Workboat, Salwico Yacht, Salwico RoPax, CS3000, CS3004, CS4000. Normal connection as spare part.

Test

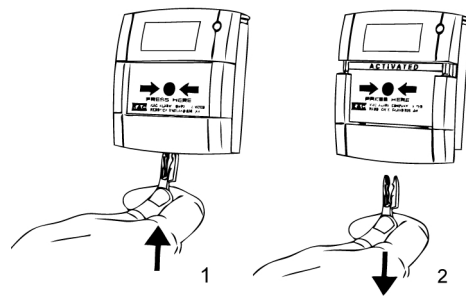

G001773

Change Glass

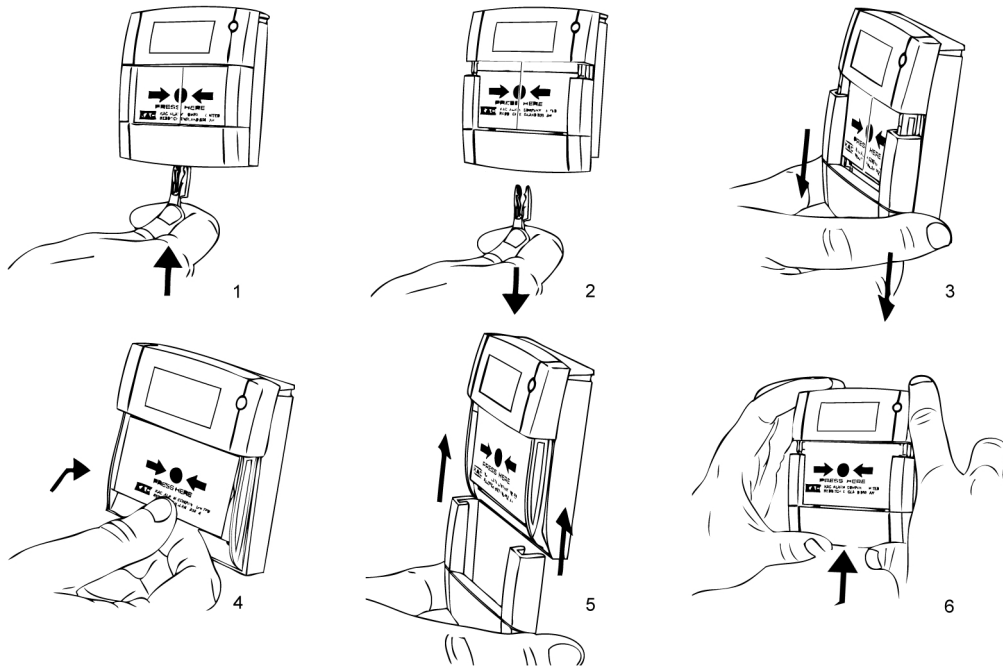

G001779

Dimensions (mm)

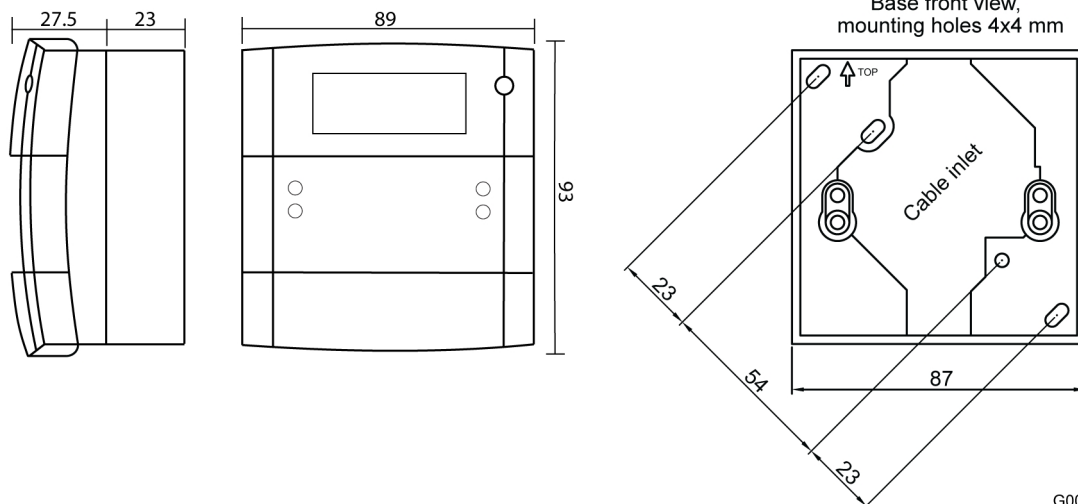

G001771

Mounting Dimensions (mm)

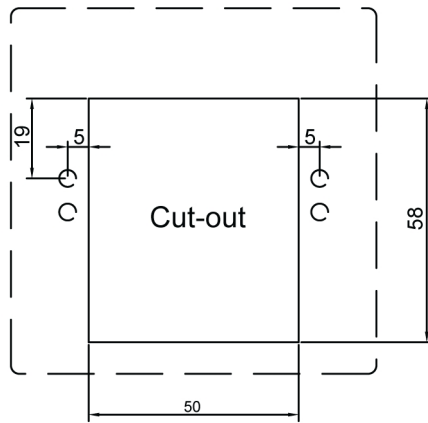

G003141