



Panel Mounted Fault Annunciator Series



➔ BSM / USM – Panel-mounted fault annunciator

- › Annunciators for panel mounting with 8, 16, 24, 32, 40 and 48 signal inputs
- › Storage of the last state of inputs and sequence in the event of power failure
- › Cascading of up to four devices to an annunciating system with up to 192 alarms possible
- › Sealed front panel, protection class IP 54
- › Integrated push buttons, function inputs, function relays, self-monitoring and internal horn
- › All established reporting sequences implemented, USM parameterisable by Web-Server
- › USM with communication interfaces acc. to IEC 60870-5-101/104 or IEC 61850
- › Optional integrated repeat-relays or DIN-rail modules for forwarding of single alarms
- › Supply and signal voltages from 12 V ... 250 V AC/DC
- › Redundant power supply in two voltage ranges available as option
- › Very bright bicolour-LEDs with large reading angle and slide-in pockets for individual labelling of LEDs and push buttons
- › Labelled plug-in screw terminals

→ General system description - annunciator variants

The fault annunciator is available in three different categories:

- BSM-C: Basic version
- BSM-P: Parameterisable version
- USM: Annunciator with protocol interfaces

The annunciators can be provided in 6 different sizes with 8, 16, 24, 32, 40 or 48 signal inputs. The signal inputs are arranged in groups of 8 alarms each. The sealed front contains 4 push buttons, bicolour-LED-displays (red/green) and slide-in pockets for labelling strips. The functions alarm acknowledgement, horn acknowledgement and lamptest are fixed assigned to the buttons for BSM-C and can be parameterized freely for BSM-P and USM.

The two function inputs are used according to the chosen alarm sequence (e.g. external acknowledgement). The integrated function relays are realized as change-over contacts. They are used for alarm specific functions (e.g. collective report or triggering of an external horn) as well as for signaling of malfunction through an alive-contact.

For parallel to input- or output forwarding of the single alarms by repeat-relays, two options are available:

1. Integration of additional relay cards (8 NO contacts each) for use as repeat output. For parameterisable annunciators BSM-P and USM the relays can be freely assigned to signal inputs. The relay cards are available as an option and have to be considered respectively when ordering.
2. Connection of external relay modules through CAN-Bus interface. Further details to these expansion modules can be found in the separate datasheet MSM-EM-DB-UK.



Further explanations to the implemented alarm sequences can be found in separate document "Description of alarm sequences" (document name SM-MA-ZI-UK).

→ BSM-C: Basic version

In the basic version, configuration of the annunciator is done by DIP-switches. The following settings can be done:

- Alarm sequence (first-up, no-first-up or operation indication)
- NO- or NC-principle of the inputs cardwise (8 inputs)
- Assignment of the alarm groups to collective reports
- Function of the collective report (standard, inverted)
- Horn triggering by subsequent alarms

The function inputs, push buttons and function relays have the following fixed functions:

- Function input 1 - external horn acknowledgement
- Function input 2 - external acknowledgement
- Button 1 - horn acknowledgement
- Button 2 - acknowledgement
- Button 3 - lamp test
- Button 4 - not used
- Relay 1 - collective report 1
- Relay 2 - collective report 2 or not used
- Relay 3 - external horn
- Relay 4 - watchdog-contact



Further Settings

- Collective report - static / output-parallel
- Horn - retriggerable by subsequent alarm and manual acknowledgement
- Horn lock - none

➔ **BSM-P: Parameterisable version**

In addition to the characteristics of the basic version the BSM-P can be parameterised through a USB-interface and can be cascaded by additional annunciators. A description of the cascading functionality can be found at the end of this section.

Parameterisation

To allow for further application specific settings, every annunciator BSM-P can be parameterised by PC-software. In addition to the settings by DIP-switch numerous additional settings are available:

The alarm sequence can be compiled from the following components:

- First-up or no-first-up alarm
- 1- or 2-frequency-flashing or steady-steady light

For each single alarm channel the following parameters can be set:

- Signal name (labelling)
- Operation indication (status indication, LED green) or fault annunciation (LED red)
- NO- or NC-principle for each signal input
- Debouncing time
- Alarm delay
- Defluttering
- Assignment to collective reports 1, 2 or 3
- Horn triggering

The following settings can be done for the **horn triggering**:

Function	Option	Description
Internal horn	Active	Internal horn is activated.
	Inactive	Internal horn is deactivated.
Horn triggering	Retriggerable	Horn is triggered by subsequent alarm, even if there are already alarms at issue.
	Not retriggerable	Horn is triggered by subsequent alarms only if no alarms are at issue.
Horn lock	Inactive	Horn can always be acknowledged.
	Active	Horn can only be acknowledged once the alarm has been acknowledged.
Horn acknowledge	Manual (continuous tone)	Horn is acknowledged manually by button or function input.
	Automatic (pulse tone)	Horn is acknowledged automatically according to the set time.

The different alarm sequences use different options for forming collective reports. In principle, the following variants may be used:

Function	Procedure
static / input-parallel	The collective report is set with the first incoming alarm and resets with the last receding alarm.
static / output-parallel	The collective report is set with the first incoming alarm. Once all alarms have receded <u>and</u> been acknowledged the collective report is reset.
static / dynamic / input-parallel	The collective report is set with the first incoming alarm. For each subsequent alarm, the collective report is reset for approx. 0.8 s and then set again. Once all alarms have receded the collective report is reset permanently.
static / dynamic / output-parallel	The collective report is set with the first incoming alarm. For each subsequent alarm, the collective report is reset for approx. 0.8 s and then set again. Once all alarms have receded <u>and</u> been acknowledged the collective report is reset permanently.
dynamic	The collective report is activated for approx. 0.8 s with each incoming alarm.
static / input-parallel / resettable	The collective report is set with the first incoming alarm and resets with the last receding alarm <u>or when acknowledged</u> .
static / output-parallel / resettable	The collective report is set with the first incoming alarm and reset independently from the state of the alarms by acknowledgement.

The following functionalities are assignable for the 4 buttons and 2 functional inputs:
Multiple assignments are possible:

- Acknowledgment lamps Group 1,2 or 3
- Reset Group 1, 2 or 3
- Acknowledgement Horn
- Lamptest

3 of the in summary 4 functional relays can be assigned with functions. The 4th relay is fixed designed as a live relay. Multiple assignments are possible:

- Collective report 1,2 or 3
- Triggering of an external horn
- Control of relays by a functional input (1 or 2)
- Triggering through one of the buttons 1 ... 4
(statically, as long as a button is pressed or as a bistable relay, toggles on each pressing of a button)
- Inversion of the relay function possible



→ Cascading

With the cascading functionality up to four devices can be grouped to an annunciating system by connecting the devices via CAN-Bus interface. One device works as “master” and the connected devices work as “slave”. Thus systems with up to 192 signal inputs (4*48) can be realized.

When creating an annunciating system, please note that the master device has to be bigger or equal to the slave devices. MSM-relay-modules cannot be connected to cascaded annunciators.

General design of a cascaded fault annunciator system:

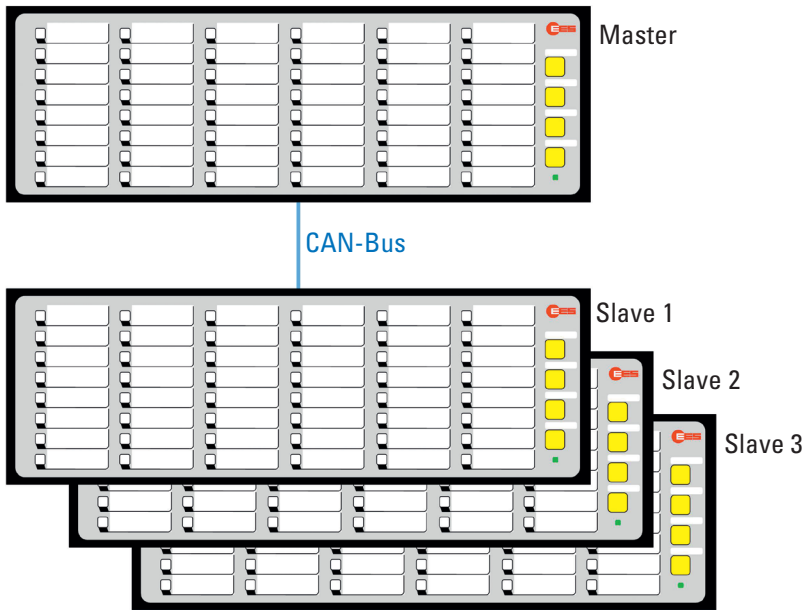

Examples:

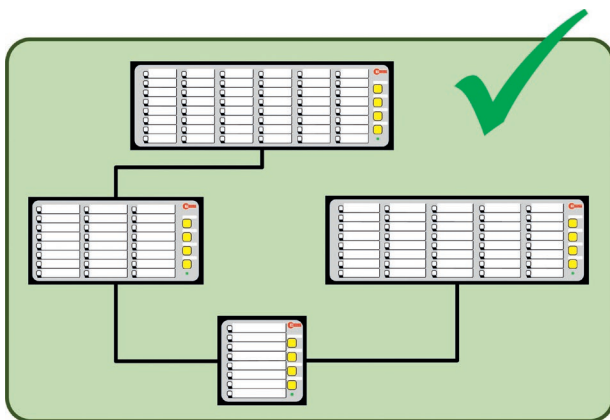

Possible

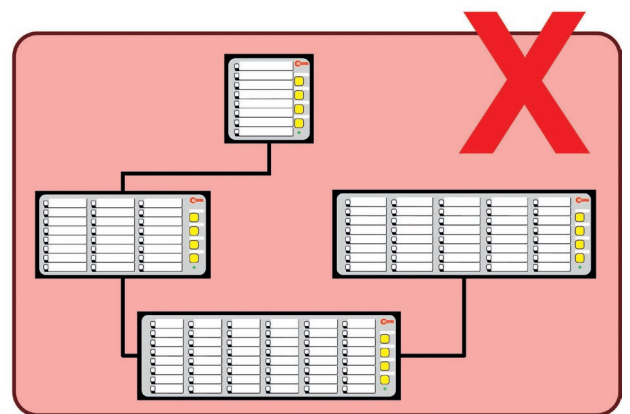

Not possible



The parameterisation is done at once via the browser-based software. Only the master device has to be connected, all other slaves receive their parameterization automatically.

→ USM: Annunciator with protocol interfaces

The USM resembles the BSM-P in general functionality. For communication with superior or inferior systems (e.g. SCADA or control systems) the USM is equipped with one or two communication cards. The communication cards provide the following interfaces:

- | | |
|--|---|
| <p>Card 1 (equipped as standard)</p> <ul style="list-style-type: none"> • 1 x Ethernet / RJ45 • 1 x RS232 / pluggable terminal • 2 x USB-A • 1 x CAN-Bus / RJ45 • 1 x USB-B (factory interface) | <p>Card 2 (optionally equipped)</p> <ul style="list-style-type: none"> • 1 x Ethernet / RJ45 • 1 x RS232 / pluggable terminal |
|--|---|

Through these interfaces the annunciators can be connected to third party systems by use of the following protocols:

- IEC 60870-5-101 (annunciator is IEC-slave)
- IEC 60870-5-104 (annunciator is IEC-server)
- IEC 61850 (annunciator is IEC-server)

▶ The annunciator can establish connections to a maximum number of 4 clients (multilink). The combination of different of the above mentioned protocols within one annunciator is possible.

1. USM as acquisition device

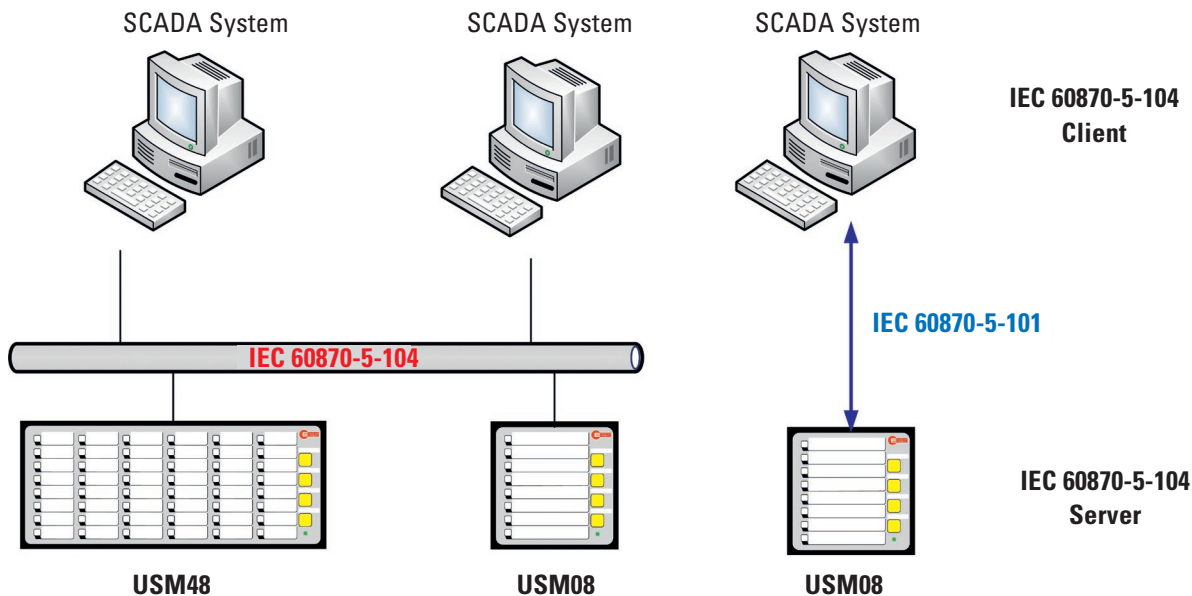

In the application example above, the USM annunciators work as acquisition devices, which process and display alarms locally. In addition the alarms are forwarded to the SCADA level through IEC 60870-5-101 or -104.

▶ The alarm channels can either be triggered from the galvanic signal input or from the IEC interface. Which of these options is used, can be parameterized individually for each channel. Acknowledgement through the IEC interface is possible as well.



2. USM as indication device

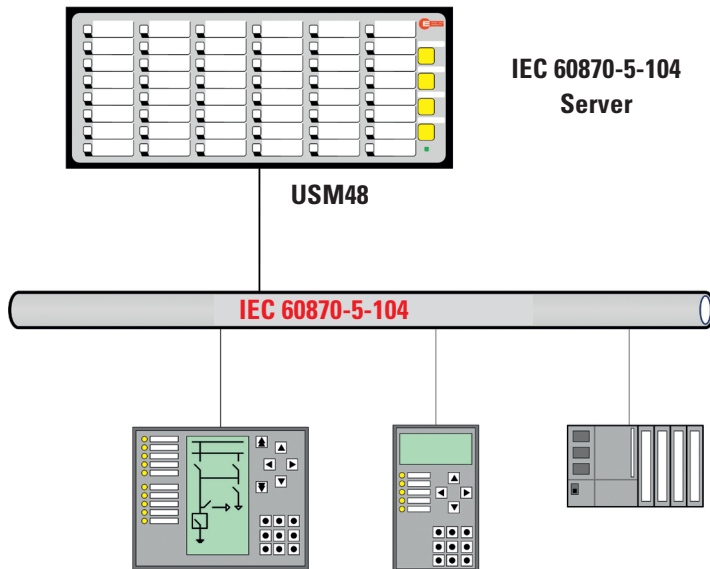

In this application example the USM processes and displays alarms that are retrieved from the IEC interface. Thus, a secondary wiring of the alarms is not necessary.

3. USM in IEC 61850 structures:

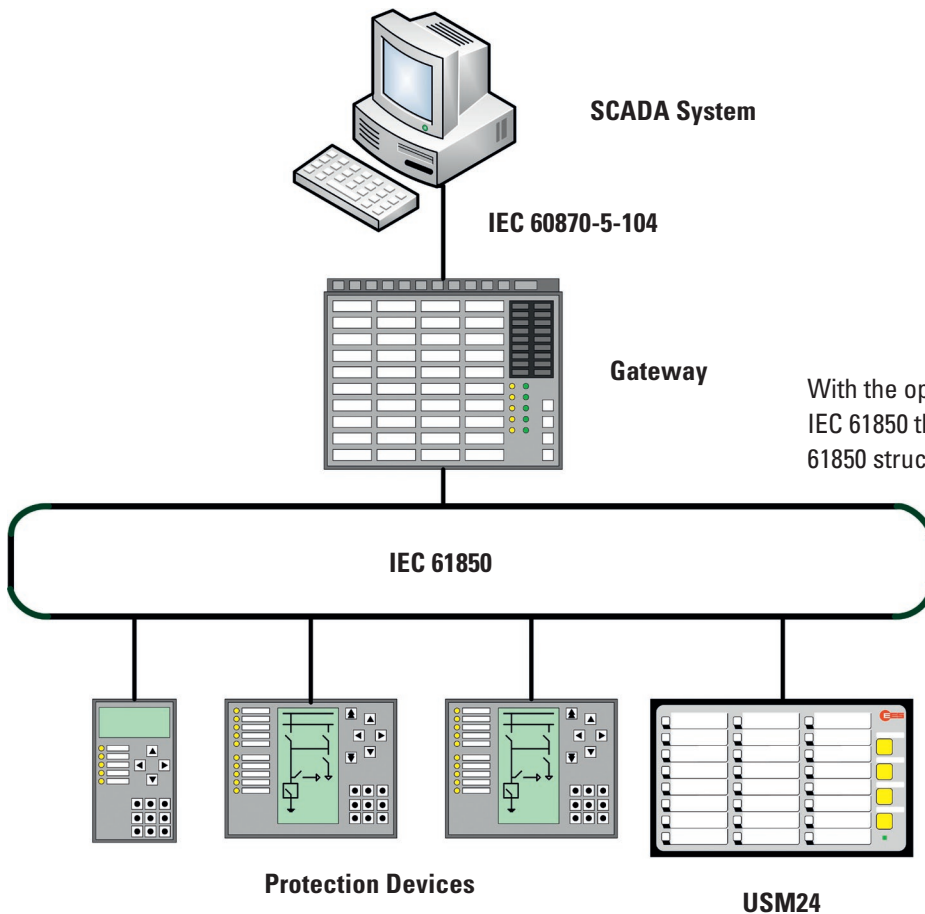

With the optionally available software license IEC 61850 the USM can be integrated into IEC 61850 structures.

The USM provides an integrated web-server. Thus the parameterization can be done via network with all current web browsers. All annunciator and interface parameters are available on the web-server and can be parameterized through it. No additional software or special cables are required! Service-access and online-monitoring are additional functions that are provided by the integrated web-server.

→ Labelling

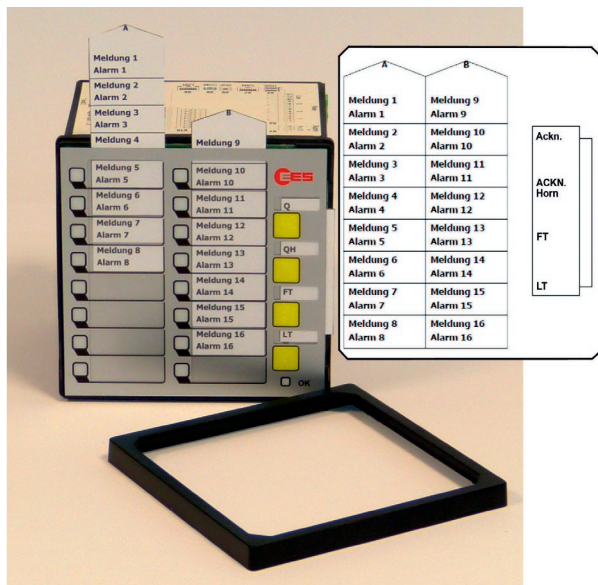

Labelling of the annunciator is done by means of designation strips that can be inserted beneath the cover foil after removing the front frame.

The designation strips with signal names can be created and printed directly from the parameterisation interface or generated manually from labelling strips in Word-format.

→ Available Options

The annunciators can be equipped with the following available options:

1. Internal relay-cards

The optionally integrated relay cards (8 NO contacts each) are independent from the 4 function relays of the annunciator and can – dependent of the annunciator version – be used for the following functions:

1. In- or output-parallel multiplication and forwarding of single alarms within the annunciator without connection of external MSM-modules
2. Triggering of the relays from the IEC-interface (only available for USM)

The assignment of the relays depends from the version of the respective annunciator:

- BSM-C - assignment of repeat relays 1:1 to signal inputs
- BSM-P - assignment of repeat relays to signal inputs individually parameterisable
- USM - individual parameterisation which input triggers the relay or if the relay is triggered from the IEC-interface

The eight normally open contacts on a relay card have one common root. The triggering and function of the relays can be parameterized by DIP-switch and by means of the parameterization software or web-server, respectively. Parameterisable settings are e.g. inversion of the signals or wipe duration for pulse outputs.



Available variants:



BSM/USM 08-R

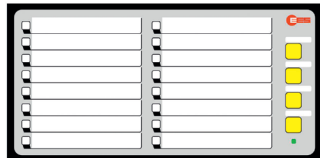

BSM/USM 16-R

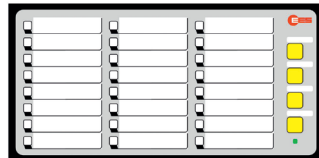

BSM/USM 24-R

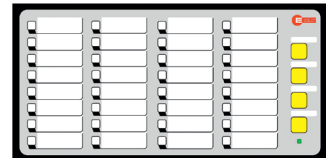

BSM/USM 32*

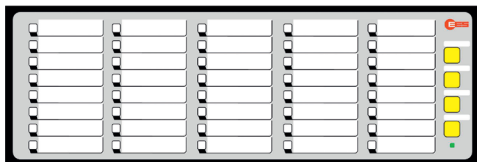

BSM/USM 40-R

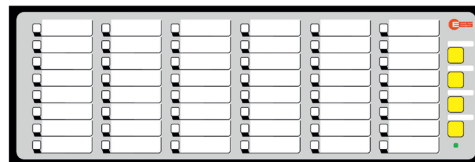

BSM/USM 48*

* With the BSM/USM 32 and BSM/USM 48 devices 2 internal relays cards (which means 16 relays contacts) can be provided.

2. Redundant power-supply

Independent from the primary power supply of the device a second, redundant power supply can be integrated into the fault annunciator. Two different voltage variants are available:

- 24 – 60 V AC/DC
- 110 – 220 V AC/DC

The voltage level of the redundant power supply can be chosen independently from the voltage level of the primary power supply. Both primary and redundant power supply are included in the self-monitoring of the annunciator and any malfunctions are signalized on the watchdog-contact and the OK-LED. Additionally the application of the supply voltage for both power supplies is indicated by a LED each on the rear side of the device. For the annunciators of the series USM the breakdown of a power supply is also signalized on the communication interface.

➔ **Technical Data**

Supply voltage U_{Sup}

Key	Rated voltage	Voltage range
0	12 V AC/DC	10...19 V DC or 8...13 V AC
1	24 V AC/DC	19...37 V DC or 4...26 V AC
2	48 V AC/DC or 60 V DC	37...73 V DC or 26...51 V AC
5	110 V AC/DC or 220 V AC/DC	100...370 V DC or 85...264 V AC

Signal voltage U_{Sig}

Key	Rated voltage [V AC/DC]	Threshold for alarm		Maximum permitted voltage [V AC/DC]	Input current per input @ rated voltage [mA]
		Inactive [V AC/DC]	Active [V AC/DC]		
0	12	3	9	35	2,3
1	24	11	15	50	2,3
3	48	17	25	75	2,1
	60	17	25	75	2,7
E	60	42	54	75	1,6
4	110	35	50	150	1,6
H	125	35	50	150	1,8
5	220	100	140	260	1,2

If not otherwise specified the given information for alternating voltage are referring to a sinusoidal alternating voltage with a frequency of 50/60 Hz

Power consumption

Number of channels	Power consumption [W]			
	BSM	BSM with integrated repeat relays	USM	USM with integrated repeat relays
8	< 4	< 6	< 8	< 10
16	< 5	< 9	< 9	< 13
24	< 5	< 13	< 10	< 17
32	< 6	< 11	< 10	< 15*
40	< 7	< 19	< 11	< 24
48	< 8	< 13	< 12	< 17*

* The power consumption of 32- and 48-way annunciators with integrated repeat relays refers to a maximum number of 2 relay cards (16 relays).

General data

Buffer time in the event of failure / short circuit	100 ms *
response delay BSM-...-C	100 ms
response delay BSM-...-P, USM	adjustable (5 ms ... 60 s)
Flashing frequency	
single frequency	2 Hz
slow flashing	0,5 Hz
Load capacity of relay contacts	24 ... 250 V AC 2 A; 110 V DC 0,5 A; 220 V DC 0,3 A
Ethernet interface	100 Base-T / RJ45

* Storage of the last state of inputs and sequence in the event of power failure.



Mechanical Data

Type BSM/USM	Front frame H x W x D [mm]	Front panel [mm]	Depth with front frame and terminals [mm]	Weight [kg]
08 08-...-R*	96 x 96 x 100	92 x 92	100	approx. 0,40
16 16-...-R*	96 x 96 x 100	92 x 92	100	approx. 0,45
24 24-...-R*	96 x 192 x 100	92 x 186	100	approx. 0,70
32 40 40-...-R*	96 x 287 x 100	92 x 282	100	approx. 1,00

* BSM/USM-...-R are variants with integrated repeat relays.

Mounting

Mounting	panel mounting
Required installation depth	120 mm
Minimum horizontal gap between 2 devices	15 mm
Connection terminals	pluggable
Wire cross section rigid or flexible	
Without wire sleeves	0,2 ... 2,5 mm ²
With wire sleeves	0,25 ... 2,5 mm ²

Ambient environment

Operating ambient temperature	-20°C +60°C
Storage temperature	-20°C +70°C
Duty cycle	100 %
Protection class at the front	IP 54
Protection class at the rear	IP 20
Humidity	75% r.h. max. on average over the year; up to 93% r.h. during 56 days; condensation during operation not permitted [Test:40°C, 93% r.h. > 4 days]

Dielectric strength

Voltage dielectric strength	
RS232/RS485 interface against	
Digital inputs	4 kV AC / 50 Hz 1 min
Relay contacts	4 kV AC / 50 Hz 1 min
Supply (110 / 230V AC/DC)	3,0 kV AC / 50 Hz 1 min
Supply (12 / 24 / 48 V AC/DC)	1,0 kV AC / 50 Hz 1 min
Relay contacts against each other	500 V / 50 Hz 1 min
Impulse withstand strength	
RS232/RS485 against	
Digital inputs	2,5 kV ; 1,2 / 50 µs; 0,5 J; acc. to IEC60255-5:2000
Relay contacts	2,5 kV ; 1,2 / 50 µs; 0,5 J; acc. to IEC60255-5:2000
Supply	2,5 kV ; 1,2 / 50 µs; 0,5 J; acc. to IEC60255-5:2000
Relay contacts against each other	500 V ; 1,2 / 50 µs; 0,5 J; acc. to IEC60255-5:2000

Electromagnetic Compatibility

Noise immunity acc. to	DIN EN 61000-4-2:2001-12
	DIN EN 61000-4-3:2008-06
	DIN EN 61000-4-4:2005-07
	DIN EN 61000-4-5:2007-06
	DIN EN 61000-4-6:2008-04
	DIN EN 61000-4-12:2007-08
Noise irradiation acc. to	DIN EN 61000-3-3:2006-06
	DIN EN 55011:2007-11



The devices are designed and manufactured for industrial applications according to EMC-standard.



Terminal assignment

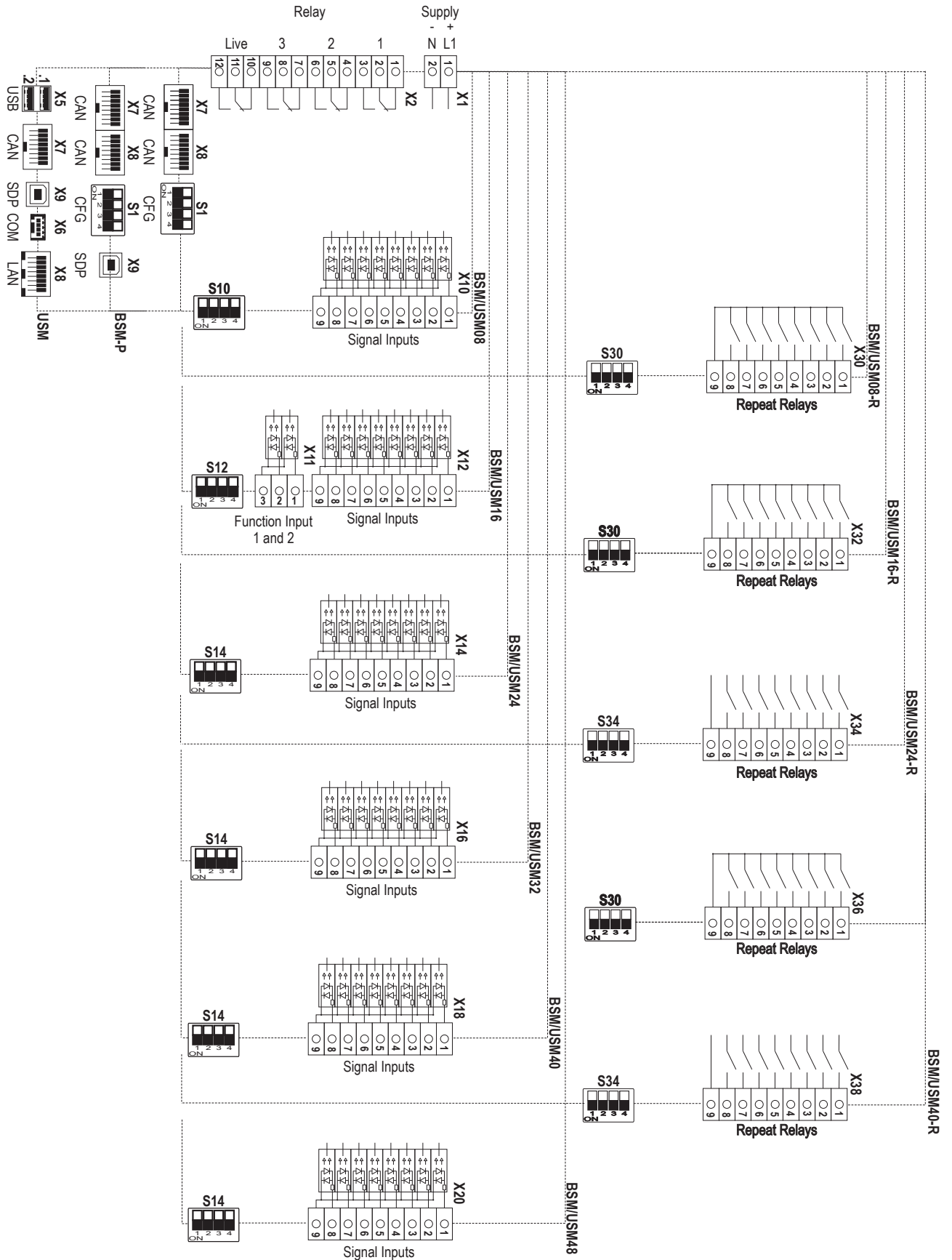

Subject to technical changes without prior notice.

➔ **Ordering Code**

BSM-C – Basic version

The spacers („X“) in the ordering code can be filled in according to the following overview:

59	B	x	x	x	x	C	x	x	x	0	Ordering Code
											Number of Signal Inputs
		0	8								8 Signal Inputs*
		1	6								16 Signal Inputs
		2	4								24 Signal Inputs
		3	2								32 Signal Inputs
		4	0								40 Signal Inputs
		4	8								48 Signal Inputs
											Supply Voltage
				1							24 V AC/DC
				2							48 - 60 V AC/DC
				5							110 - 220 V AC/DC
											Signal Voltage
					1						24 V AC/DC
					3						48 - 60 V AC/DC
					4						110 V AC/DC
					H						125 V AC/DC
					5						220 V AC/DC
											LED-Colour
							D				Bicolour-LED, colour parameterisable (red, green)
							X				Customized mixed assembly of single-coloured LEDs
											Integrated Repeat-Relays
								0			no repeat relays
								R			8 repeat relays (for annunciator with 8 signal inputs)
								R			16 repeat relays (for annunciator with 16 signal inputs)
								R			24 repeat relays (for annunciator with 24 signal inputs)
								R			40 repeat relays (for annunciator with 40 signal inputs)
											Redundant Power Supply
									0		no redundant power supply
									1		24 - 60 V AC/DC
									5		110 - 220 V AC/DC

59 B C 0 **Ordering Code**

* Please note that the terminal designations have been changed compared to the predecessor model SRL08.

Example for ordering

59B1655CDR10 BSM with 16 signal inputs
 Supply voltage 220 V
 Signal voltage 220 V
 Bicolour-LEDs
 Repeat-relays
 Redundant power supply 24 – 60 V

 For BSM with 32 and 48 signal channels the option integrated repeat relays is not available.



BSM-P -- Parameterisable Version

The spacers („X“) in the ordering code can be filled in according to the following overview:

59	B	x	x	x	x	P	x	x	x	0	
											Number of Signal Inputs
		0	8								8 Signal Inputs
		1	6								16 Signal Inputs
		2	4								24 Signal Inputs
		3	2								32 Signal Inputs
		4	0								40 Signal Inputs
		4	8								48 Signal Inputs
											Supply Voltage
				1							24 V AC/DC
				2							48 - 60 V AC/DC
				5							110 - 220 V AC/DC
											Signal Voltage
				1							24 V AC/DC
				3							48 - 60 V AC/DC
				4							110 V AC/DC
				H							125 V AC/DC
				5							220 V AC/DC
											LED-Colour
							D				Bicolour-LED, colour parameterisable (red, green)
							X				Customized mixed assembly of single-coloured LEDs
											Integrated Repeat-Relays
								0			no repeat relays
								R			8 repeat relays (for annunciator with 8 signal inputs)
								R			16 repeat relays (for annunciator with 16 signal inputs)
								R			24 repeat relays (for annunciator with 24 signal inputs)
								R			40 repeat relays (for annunciator with 40 signal inputs)
								1			8 repeat relays (independent from no. of signal inputs)
								2			16 repeat relays (independent from no. of signal inputs)
											Redundant Power Supply
								0			no redundant power supply
								1			24 - 60 V AC/DC
								5			110 - 220 V AC/DC

59 B P 0 **Ordering Code**

Example for ordering

59B1655PDR10 Parameterisable BSM with 16 signal inputs
 Supply voltage 220 V
 Signal voltage 220 V
 Bicolour-LEDs
 Repeat-relays
 Redundant power supply 24 – 60 V



For BSM with 32 and 48 signal channels the option integrated repeat relays is not available.

USM – Annunciator with protocol interfaces

The spacers („X“) in the ordering code can be filled in according to the following overview:

59	U	x	x	x	x	W	x	x	x	x	
											Number of Signal Inputs
		A									8 Signal Inputs
		B									16 Signal Inputs
		C									24 Signal Inputs
		D									32 Signal Inputs
		E									40 Signal Inputs
		F									48 Signal Inputs
											Supply Voltage
			1								24 V AC/DC
			2								48 - 60 V AC/DC
			5								110 - 220 V AC/DC
											Signal Voltage
				1							24 V AC/DC
				3							48 - 60 V AC/DC
				4							110 V AC/DC
				H							125 V AC/DC
				5							220 V AC/DC
											Device Type
					E						Acquisition device
											Protocol Interface Card 1
						W					IEC60870-5-101/-104
											Protocol Interface Card 2
							0				not equipped
							W				IEC60870-5-101/-104
											LED-Colour
							D				Bicolour-LED, colour parameterisable (red, green)
							X				Customized mixed assembly of single-coloured LEDs
											Integrated Repeat-Relays
								0			no repeat relays
								R			8 repeat relays (for annunciator with 8 signal inputs)
								R			16 repeat relays (for annunciator with 16 signal inputs)
								R			24 repeat relays (for annunciator with 24 signal inputs)
								R			40 repeat relays (for annunciator with 40 signal inputs)
								1			8 repeat relays (independent from no. of signal inputs)
								2			16 repeat relays (independent from no. of signal inputs)
											Redundant Power Supply
									0		no redundant power supply
									1		24 - 60 V AC/DC
									5		110 - 220 V AC/DC

59 U W **Ordering Code**

Ordering Code 59ZLICP61850 - License key for IEC 61850 communication

Example for ordering

59UB55EW0DR1 USM with 16 signal inputs
 Supply voltage 220 V / Signal voltage 220 V
 1. Interface card IEC 608970-5-101/104
 2. Interface card not equipped
 Bicolour-LEDs / Repeat-relays / Redundant power supply 24 – 60 V



For USM with 32 and 48 signal channels the option integrated repeat relays is not available. Up to max. 2 integrated relay cards can be equipped. These relays can be assigned to inputs or triggered from the interface.

→ contact

Elektra Elektronik GmbH & Co Störcontroller KG | Hummelbühl 7-7/1 | 71522 Backnang/Germany
 phone: +49 (0) 7191/182-0 | fax: +49 (0) 7191/182-200 | E-Mail: info@ees-online.de | Internet: www.ees-online.de

