



# Compact cylinder—ACQ Series

## Compendium of ACQ Series

**In accordance with JIS standard**

**Magnetic switch slots around the cylinder body**  
There are magnetic switch slots around the cylinder body convenient to install inducting switch.

**Two kinds of rod type**

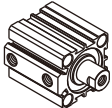

Female thread

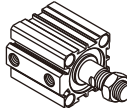

Male thread

**Multi-mounting accessories**

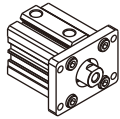

FA Type

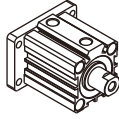

FB Type

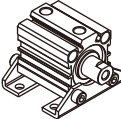



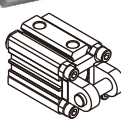



LB Type



CB Type

**Thirteen bore size are available**  
Bore size: 12, 16, 20, 25, 32, 40, 50, 63, 80, 100, 125, 140, 160

**Multi-type cylinder**

ACQ: Compact cylinder (Double acting)	
ASQ: Compact cylinder (Single acting-push)	
ATQ: Compact cylinder (Single acting-pull)	
ACQD: Compact cylinder (Double rod)	
ACQJ: Compact cylinder (Adjustable stroke)	
TACQ: Compact cylinder (Double acting with guider)	

**Compact structure**  
C clip is adopted to connect the cylinder body and back cover or front cover, and riveted structure is adopted to connect piston and piston rod to make it compact and reliable.

### Criteria for selection: Cylinder thrust

Unit: Newton(N)

Bore size	Rod size	Acting type	Pressure area(mm <sup>2</sup> )	Operating pressure(MPa)							
				0.1	0.2	0.3	0.4	0.5	0.6	0.7	
12	6	Single acting	Push side	113.1	-	13.6	24.9	36.2	47.5	58.9	70.2
			Pull side	84.8	-	8.0	16.4	24.9	33.4	41.9	50.4
		Double acting	Push side	113.1	11.3	22.6	33.9	45.2	56.5	67.9	79.2
			Pull side	84.8	8.5	17.0	25.4	33.9	42.4	50.9	59.4
16	8	Single acting	Push side	201.1	-	27.0	47.1	67.2	87.3	107.4	127.5
			Pull side	150.8	-	17.0	32.0	47.1	62.2	77.3	92.4
		Double acting	Push side	201.1	20.1	40.2	60.3	80.4	100.5	120.6	140.7
			Pull side	150.8	15.1	30.2	45.2	60.3	75.4	90.5	105.6
20	10	Single acting	Push side	314.2	-	36.8	68.2	99.7	131.1	162.5	193.9
			Pull side	235.6	-	21.1	44.7	68.2	91.8	115.4	138.9
		Double acting	Push side	314.2	31.4	62.8	94.2	125.7	157.1	188.5	219.9
			Pull side	235.6	23.6	47.1	70.7	94.2	117.8	141.4	164.9
25	12	Single acting	Push side	490.9	18.1	67.2	116.3	165.3	214.4	263.5	312.6
			Pull side	377.8	6.8	44.6	82.3	120.1	157.9	195.7	233.4
		Double acting	Push side	490.9	49.1	98.2	147.3	196.3	245.4	294.5	343.6
			Pull side	377.8	37.8	75.6	113.3	151.1	188.9	226.7	264.4
32	16	Single acting	Push side	804.2	27.4	107.8	188.3	268.7	349.1	429.5	510.0
			Pull side	603.2	7.3	67.6	128.0	188.3	248.6	308.9	369.2
		Double acting	Push side	804.2	80.4	160.8	241.3	321.7	402.1	482.5	563.0
			Pull side	603.2	60.3	120.6	181.0	241.3	301.6	361.9	422.2
40	16	Single acting	Push side	1256.6	44.7	170.3	296.0	421.7	547.3	673.0	798.6
			Pull side	1055.6	24.6	130.1	235.7	341.2	446.8	552.3	657.9
		Double acting	Push side	1256.6	125.7	251.3	377.0	502.7	628.3	754.0	879.6
			Pull side	1055.6	105.6	211.1	316.7	422.2	527.8	633.3	738.9
50	20	Single acting	Push side	1963.5	96.3	292.7	489.0	685.4	881.7	1078.1	1274.4
			Pull side	1649.3	64.9	229.9	394.8	559.7	724.7	889.6	1054.5
		Double acting	Push side	1963.5	196.3	392.7	589.0	785.4	981.7	1178.1	1374.4
			Pull side	1649.3	164.9	329.9	494.8	659.7	824.7	989.6	1154.5
63	20	Single acting	Push side	3117.2	141.7	453.4	765.2	1076.9	1388.6	1700.3	2012.1
			Pull side	2803.1	110.3	390.6	670.9	951.2	1231.5	1511.9	1792.2
		Double acting	Push side	3117.2	311.7	623.4	935.2	1246.9	1558.6	1870.3	2182.1
			Pull side	2803.1	280.3	560.6	840.9	1121.2	1401.5	1681.9	1962.2
80	25	Double acting	Push side	5026.5	502.7	1005.3	1508.0	2010.6	2513.3	3015.9	3518.6
			Pull side	4535.7	453.6	907.1	1360.7	1814.3	2267.8	2721.4	3175.0
		Single acting	Push side	7854.0	785.4	1570.8	2356.2	3141.6	3927.0	4712.4	5497.8
			Pull side	7049.7	705.0	1409.9	2114.9	2819.9	3524.9	4229.8	4934.8
100	32	Double acting	Push side	12271.8	1227.2	2454.4	3681.5	4908.7	6135.9	7363.1	8590.2
			Pull side	11467.6	1146.8	2293.5	3440.3	4587.0	5733.8	6880.6	8027.3
		Single acting	Push side	15393.8	1539.4	3078.8	4618.1	6157.5	7696.9	9236.3	10775.7
			Pull side	14589.6	1459.0	2917.9	4376.9	5835.8	7294.8	8753.8	10212.7
140	32	Double acting	Push side	20106.2	2010.6	4021.2	6031.9	8042.5	10053.1	12063.7	14074.3
			Pull side	18849.6	1885.0	3769.9	5654.9	7539.8	9424.8	11309.8	13194.7

### Installation and application



1. When load changes in the work, the cylinder with abundant output capacity shall be selected.
2. Relative cylinder with high temperature resistance or corrosion resistance shall be chosen under the condition of high temperature or corrosion.
3. Necessary protection measure shall be taken in the environment with higher humidity, much dust or water drops, oil dust and welding dregs.
4. Dirty substances in the pipe must be eliminated before cylinder is connected with pipeline to prevent the entrance of particles into the cylinder.
5. The medium used by cylinder shall be filtered to 40 μm or below.
6. As both of the front cover and piston of the cylinder are short, typically too large stroke can not be selected.
7. Anti-freezing measure shall be adopted under low temperature environment to prevent moisture freezing.
8. The cylinder shall avoid the influence of side load in operation to maintain the normal work of cylinder and extend the service life.
9. If the cylinder is dismantled and stored for a long time, please conduct anti-rust treatment to the surface. Anti-dust caps shall be added in air inlet and outlet ports. The front and back cover can not be dismantled, which shall be especially noticed.
10. C clip Installation:
  - 10.1. Removal & Installation of C clip must be done with proper tool & care.
  - 10.2. Ensure C clip is securely fitted into the proper slot to prevent leakage.



# Compact cylinder

## ACQ Series



### Specification

Bore size(mm)		12	16	20	25	32	40	50	63	80	100
Acting type		Double acting									
		Single acting_Push type、Single acting_Pull type									
Fluid		Air(to be filtered by 40 μm filter element)									
Operating pressure	Double acting	0.15~1.0MPa(22~145psi)									
	Single acting	0.2~1.0MPa(28~145psi)									
Proof pressure		1.5MPa(215psi)									
Temperature °C		-20~70									
Speed range mm/s		Double acting: 30~500 Single acting: 50~500									
Stroke tolerance		Stroke≤100 <sup>+1.0</sup> <sub>0</sub> Stroke>100 <sup>+1.5</sup> <sub>0</sub>									
Cushion type		Bumper									
Port size [Note1]		M5×0.8			1/8"			1/4"		3/8"	

[Note1] G thread is available.  
Add) Refer to P451 for detail of sensor switch.

### Symbol

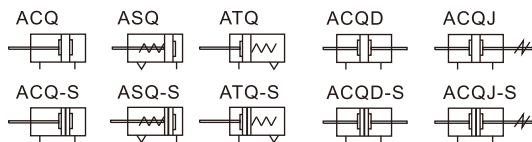

### Product feature

- JIS standard is implemented.
- C clip is adopted to connect the cylinder body and back cover or front cover, and riveted structure is adopted to connect piston and piston rod to make it compact and reliable.
- The internal diameter of the body is treated with rolling followed by the treatment of hard anodizing, forming an excellent abrasion resistance and durability.
- The seal of piston adopts heterogeneous two-way seal structure. It has compact dimension and the function of grease reservation.
- Compact structure can effectively save installation space.
- There are magnetic switch slots around the cylinder body, which is convenient to install inducting switch.
- Installing accessories with various specifications are optional.

### Stroke

Bore size (mm)		Standard stroke (mm)									Max.std stroke	Max.stroke								
												Standard	With magnet							
12	Double acting	5	10	15	20	25	30	35	40	45	50	50	80	70						
	Single acting	5	10	15	20										20	-	-			
16	Double acting	5	10	15	20	25	30	35	40	45	50	55	60	60	80	70				
	Single acting	5	10	15	20										20	-	-			
20	Double acting	5	10	15	20	25	30	35	40	45	50	60	70	75	80	90	100	100	140	130
	Single acting	5	10	15	20	25	30										30	-	-	
32	Double acting	5	10	15	20	25	30	35	40	45	50	60	70	75	80	90	100	100	100	100
	Single acting	5	10	15	20	25	30													
40	Double acting	5	10	15	20	25	30													
	Single acting	5	10	15	20	25	30													
50	Double acting	5	10	15	20	25	30													
	Single acting	5	10	15	20	25	30													
63	Double acting	5	10	15	20	25	30													
	Single acting	5	10	15	20	25	30													
80	Double acting	5	10	15	20	25	30	35	40	45	50	60	70	75	80	90	100	100	-	-
	Single acting	5	10	15	20	25	30													
100	Double acting	5	10	15	20	25	30	35	40	45	50	60	70	75	80	90	100	100	-	-
	Single acting	5	10	15	20	25	30													

Note) 1. Please contact the company for other special strokes.  
2. The dimensions of non-std stroke cylinder has the same dimensions as the next longer stroke std. stroke cylinder. e.g. 23mm stroke cylinder has the same dimensions of 25 std. stroke cylinder.

### Ordering code

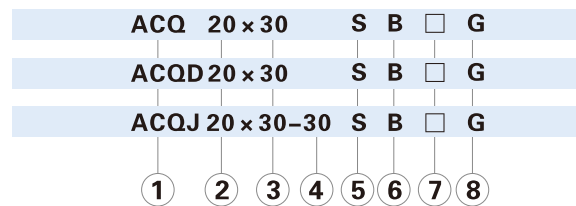

① Model	② Bore size	③ Stroke	④ Adjustable Stroke	⑤ Magnet	⑥ Rod type	⑦ Mounting type [Note1]	⑧ Thread type [Note2]
ACQ: Compact cylinder (Double acting)	12 16 20 25 32 40 50 63 80 100	Refer to stroke table for details	No this code	Blank: Without magnet S: With magnet	Blank: Female thread B: Male thread	Blank: No accessories FA: FA type FB: FB type CB: CB type LB: LB type	G: G
ASQ: Compact cylinder (Single acting-push)	12 16 20 25 32 40 50 63						
ATQ: Compact cylinder (Single acting-pull)	12 16 20 25 32 40 50 63						
ACQD: Compact cylinder (Double rod)	12 16 20 25 32 40 50 63						
ACQJ: Compact cylinder (Adjustable stroke)	80 100						
			10 20 30 40 50 75 100			Blank: No accessories FA: FA type FB: FB type LB: LB type	

[Note1] Please refer to page 269~270 for accessory parts.  
[Note2] Standard thread is blank here.

# Compact cylinder

## ACQ Series

### Inner structure and material of major parts

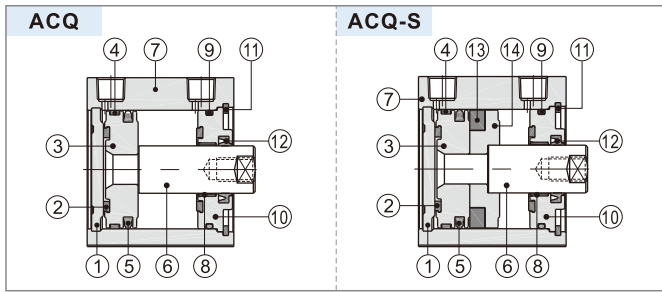

NO.	Item	Material
1	Back cover	No(Φ 12, 16)\Aluminum alloy(Others)
2	Bumper	TPU(Φ 12~25)\NBR(Others)
3	Piston	Brass(Φ 12, 16)\Aluminum alloy(Others)
4	Wear ring	No(Φ 12~32)\Wear resistant material(Others)
5	Piston seal	NBR
6	Piston rod	Carbon steel with 20 μ m chrome plated
7	Body	Aluminum alloy
8	Bushing	No(Φ 12~32)\Wear resistant material(Others)
9	O-ring	NBR
10	Front cover	Aluminum alloy
11	C clip	Spring steel
12	Front cover packing	NBR
13	Magnet	Sintered metal(Neodymium-iron-boron)(Φ 12~25)\Plastic(Others)
14	Magnet holder	Brass(Φ 12, 16)\Aluminum alloy(Others)

### Dimensions

**ACQ**  
Φ 12、Φ 16

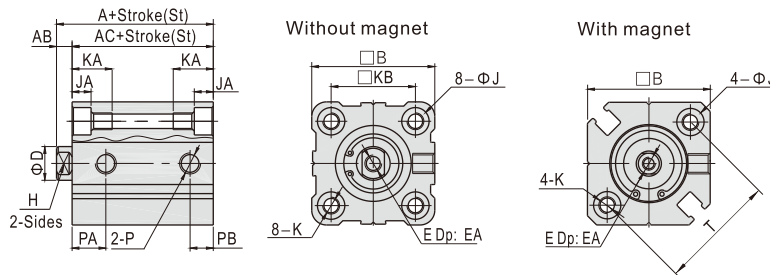

Φ 20、Φ 25

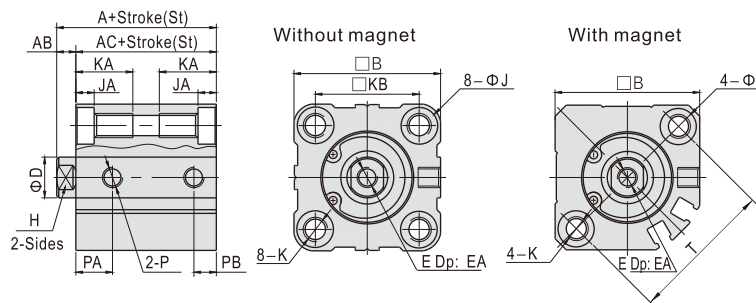

Type	Without magnet						With magnet														Without magnet		With magnet		
	A			AC			A	AC	AB	B	D	E	EA	H	J	JA	K	KA	KB	P	PA	PB	PA	PB	T
Bore size\Item	St≤50	St=55	St≥60	St≤50	St=55	St≥60																			
12	20.5	-	-	17	-	-	31.5	28	3.5	25	6	M3×0.5	6	5	6	3.5	M4×0.7 Thru.hole: Φ3.4	11	15.5	M5×0.8	7.5	5	9	7	22
16	22	22	-	18.5	18.5	-	34	30.5	3.5	29	8	M4×0.7	8	6	6	3.5	M4×0.7 Thru.hole: Φ3.4	11	20	M5×0.8	8	5.5	9.5	5.5	28
20	24	-	34	19.5	-	29.5	36	31.5	4.5	36	10	M5×0.8	7	8	9	5.5	M6×1.0 Thru.hole: Φ5.2	17	25.5	M5×0.8	9	5.5	9.5	5.5	36
25	27.5	-	37.5	22.5	-	32.5	37.5	32.5	5	40	12	M6×1.0	12	10	9	5.5	M6×1.0 Thru.hole: Φ5.2	17	28	M5×0.8	11	5.5	11	5.5	40

Φ 32~Φ 100 (Stroke≤100)

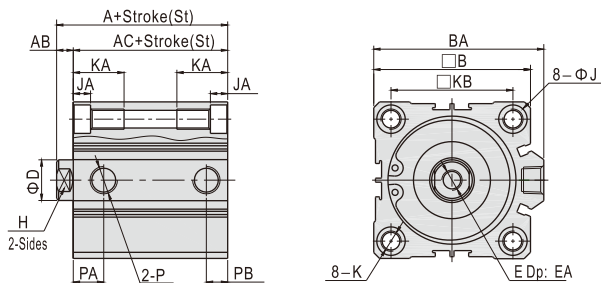

Item	A(Without magnet)		A (With magnet)	AB	AC(Without magnet)		AC (With magnet)	B	BA	D	E
	St≤50	St≥60			St≤50	St≥60					
Bore size	St≤50	St≥60	(With magnet)		St≤50	St≥60	(With magnet)				
32	30	40	40	7	23	33	33	45	49.5	16	M8×1.25
40	36.5	46.5	46.5	7	29.5	39.5	39.5	53	57	16	M8×1.25
50	38.5	48.5	48.5	8	30.5	40.5	40.5	64	71	20	M10×1.5
63	44	54	54	8	36	46	46	77	84	20	M10×1.5
80	53.5	63.5	63.5	10	43.5	53.5	53.5	98	104	25	M16×2.0
100	65	75	75	12	53	63	63	117	123.5	32	M20×2.5

Item	Bore size	EA	H	J	JA	K	KA	KB	P	Without magnet		With magnet	
										PA	PB	PA	PB
32	St=5	13	14	9	5.5	M6×1.0 Thru.hole: Φ5.2	17	34	1/8"	7.5	6.5	10.5	7.5
	St>5	10.5	7.5										
40	St=5	13	14	9	5.5	M6×1.0 Thru.hole: Φ5.2	17	40	1/8"	11	8	11	8
	St>5	10.5	7.5										
50	St=5	15	17	10.5	6.5	M8×1.25 Thru.hole: Φ6.8	22	50	1/4"	9	9	10.5	10.5
	St>5	10.5	10.5										
63	St=5	15	17	14	9	M10×1.5 Thru.hole: Φ8.5	28.5	60	1/4"	14	9.5	15	10.5
	St>5	10.5	10.5										
80	St=5	20	22	17	11	M12×1.75 Thru.hole: Φ10.3	35.5	77	3/8"	16	14	16	14
	St>5	10.5	10.5										
100	St=5	26	27	17	11	M12×1.75 Thru.hole: Φ10.3	35.5	94	3/8"	20	17.5	20	17.5
	St>5	10.5	10.5										

Note) The dimensions of non-std stroke cylinder has the same dimensions as the next longer stroke std. stroke cylinder. e.g. 55mm stroke cylinder has the same dimensions of 60 std. stroke cylinder.

# Compact cylinder

## ACQ Series

### ASQ

Φ12、Φ16

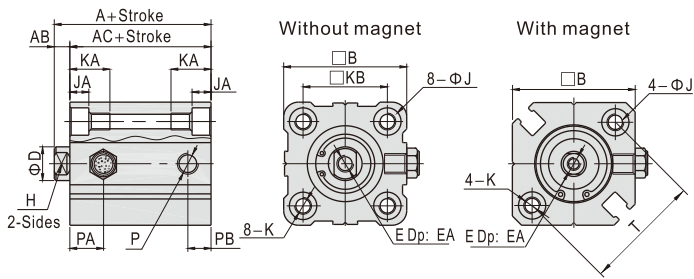

### ATQ

Φ12、Φ16

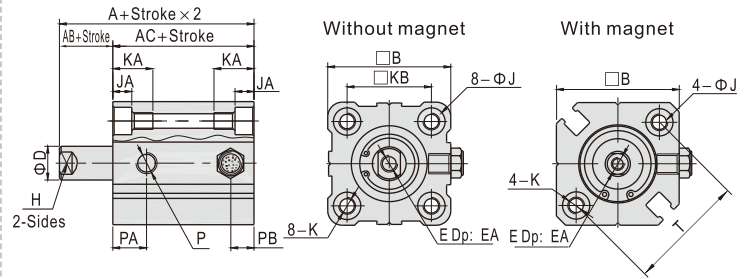

Φ20 Φ25

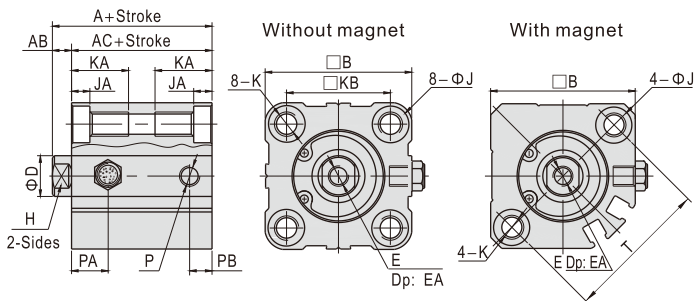

Φ20 Φ25

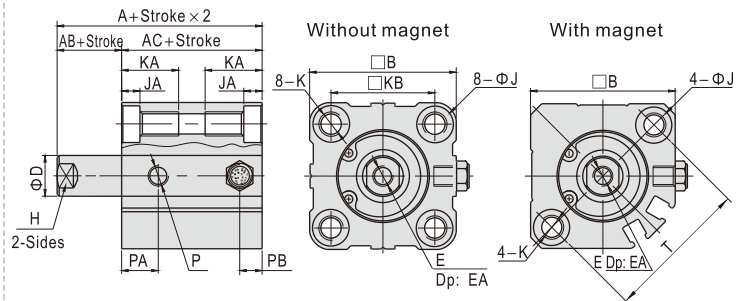

Φ32~Φ63

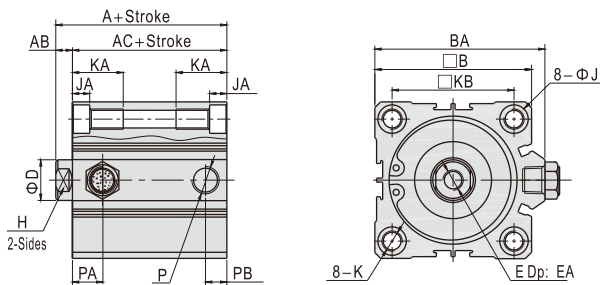

Φ32~Φ63

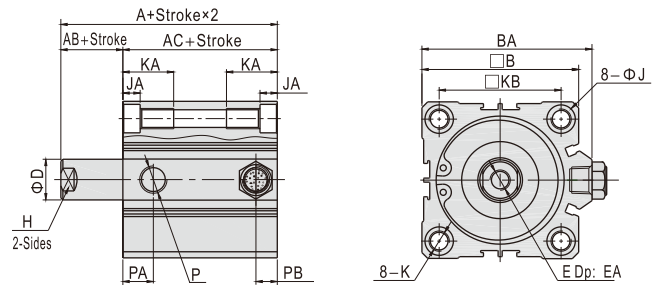

Bore size\Item Stroke	A(Without magnet)			A(With magnet)			AB	AC(Without magnet)			AC(With magnet)			B	BA	D	E	EA
	5\10	15\20	25\30	5\10	15\20	25\30		5\10	15\20	25\30	5\10	15\20	25\30					
12	25.5	30.5	-	36.5	41.5	-	3.5	22	27	-	33	38	-	25	-	6	M3×0.5	6
16	27	32	-	39	44	-	3.5	23.5	28.5	-	35.5	40.5	-	29	-	8	M4×0.7	8
20	29	34	39	41	46	51	4.5	24.5	29.5	34.5	36.5	41.5	46.5	36	-	10	M5×0.8	7
25	32.5	37.5	42.5	42.5	47.5	52.5	5	27.5	32.5	37.5	37.5	42.5	47.5	40	-	12	M6×1.0	12
32	35	40	45	45	50	55	7	28	33	38	38	43	48	45	49.5	16	M8×1.25	13
40	41.5	46.5	51.5	51.5	56.5	61.5	7	34.5	39.5	44.5	44.5	49.5	54.5	53	57	16	M8×1.25	13
50	48.5	53.5	58.5	58.5	63.5	68.5	8	40.5	45.5	50.5	50.5	55.5	60.5	64	71	20	M10×1.5	15
63	54	59	64	64	69	74	8	46	51	56	56	61	66	77	84	20	M10×1.5	15

Bore size\Item	H	J	JA	K		KA	KB	P	PA(Without magnet)	PA(With magnet)	PB(Without magnet)	PB(With magnet)	T
				M	Thru.hole								
12	5	6	3.5	M4×0.7	Φ3.4	11	15.5	M5×0.8	7.5	9	5	7	22
16	6	6	3.5	M4×0.7	Φ3.4	11	20	M5×0.8	8	9.5	5.5	5.5	28
20	8	9	5.5	M6×1.0	Φ5.2	17	25.5	M5×0.8	9	9.5	5.5	5.5	36
25	10	9	5.5	M6×1.0	Φ5.2	17	28	M5×0.8	11	11	5.5	5.5	40
32	14	9	5.5	M6×1.0	Φ5.2	17	34	1/8"	10.5	10.5	7.5	7.5	-
40	14	9	5.5	M6×1.0	Φ5.2	17	40	1/8"	11	11	8	8	-
50	17	10.5	6.5	M8×1.25	Φ6.8	22	50	1/4"	10.5	10.5	10.5	10.5	-
63	17	14	9	M10×1.5	Φ8.5	28.5	60	1/4"	15	15	10.5	10.5	-

# Compact cylinder

## ACQ Series

### ACQD

Φ12、Φ16

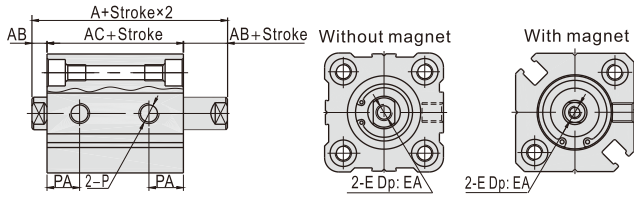

### ACQJ

Φ12、Φ16

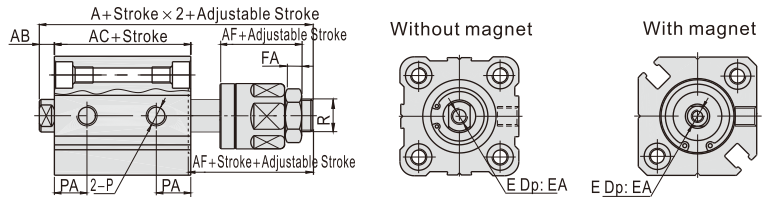

Φ20 Φ25

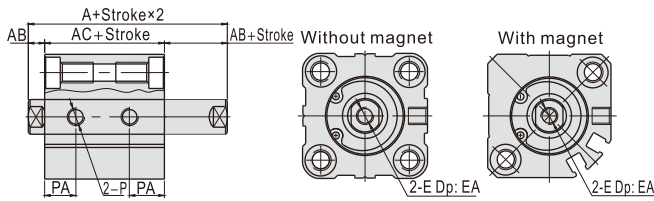

Φ20 Φ25

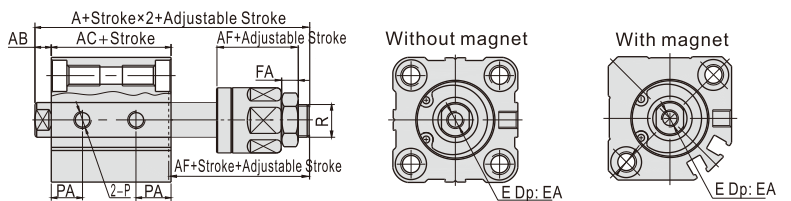

Φ32~Φ100

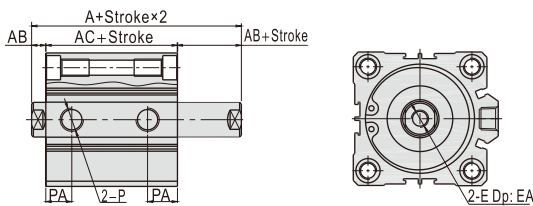

Φ32~Φ100

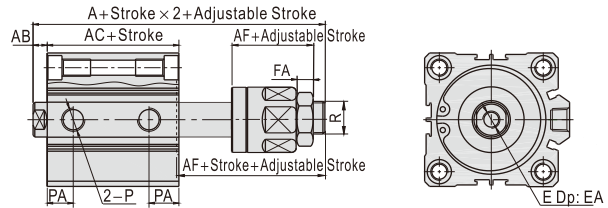

Item	A(ACQD)		A(ACQJ)		AC(ACQD)		AC(ACQJ)		AB	AF	E	EA	FA	PA	R
	Without magnet	With magnet	Without magnet	With magnet	Without magnet	With magnet	Without magnet	With magnet							
12	32.2	39.4	45.2	52.4	25.2	32.4	25.2	32.4	3.5	17	M3 × 0.5	6	4	9	M5 × 0.8
16	33	43	50	60	26	36	26	36	3.5	21	M4 × 0.7	8	5	9.5	M6 × 1.0
20	35	47	55	67	26	38	26	38	4.5	25	M5 × 0.8	7	6	9.5	M8 × 1.25
25	39	49	60.5	70.5	29	39	29	39	5	27	M6 × 1.0	9.5(St≤5)/12(St>5)	6	11	M10 × 1.25
32	44.5	54.5	64.9	74.9	30.5	40.5	30.5	40.5	7	28	M8 × 1.25	9(St≤10)/13(St>10)	7	10	M12 × 1.25
40	54	64	74.5	84.5	40	50	40	50	7	28	M8 × 1.25	11(St≤10)/13(St>10)	7	13	M12 × 1.25
50	56.5	66.5	77	87	40.5	50.5	40.5	50.5	8	29	M10 × 1.5	12(St≤10)/15(St>10)	8	13.5	M16 × 1.5
63	58	68	78.4	88.4	42	52	42	52	8	29	M10 × 1.5	12(St≤10)/15(St>10)	8	14.5(St=5)/16(St>5)	M16 × 1.5
80	71	81	95.8	105.8	51	61	51	61	10	35.5	M16 × 2.0	14(St≤15)/20(St>15)	10	16	M20 × 1.5
100	84.5	94.5	114.3	124.3	60.5	70.5	60.5	70.5	12	42.5	M20 × 2.5	20(St≤25)/26(St>25)	13.5	21	M27 × 2.0

Remark) The unmarked dimension is the same as ACQ standard type. Please refer to this page for male thread dimensions.

### Male thread

(Bore size: Φ12~Φ100, Stroke≤100)

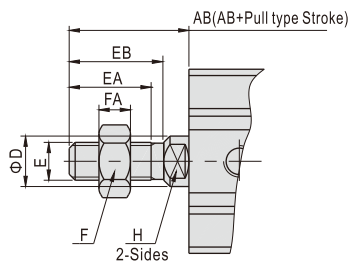

Bore size/Item	AB	D	E	EA	EB	F	FA	H
12	14	6	M5 × 0.8	9	10.5	8	4	5
16	15.5	8	M6 × 1.0	10	12	10	5	6
20	18.5	10	M8 × 1.25	12	14	12	6	8
25	22.5	12	M10 × 1.25	15	17.5	17	6	10
32	28.5	16	M14 × 1.5	20.5	23.5	19	8	14
40	28.5	16	M14 × 1.5	20.5	23.5	19	8	14
50	33.5	20	M18 × 1.5	26	28.5	27	11	17
63	33.5	20	M18 × 1.5	26	28.5	27	11	17
80	43.5	25	M22 × 1.5	32.5	35.5	32	13	22
100	43.5	32	M26 × 1.5	32.5	35.5	36	13	27